

Flexibility in thermal power plants

With a focus on existing coal-fired power plants

STUDY

Agora
Energiewende

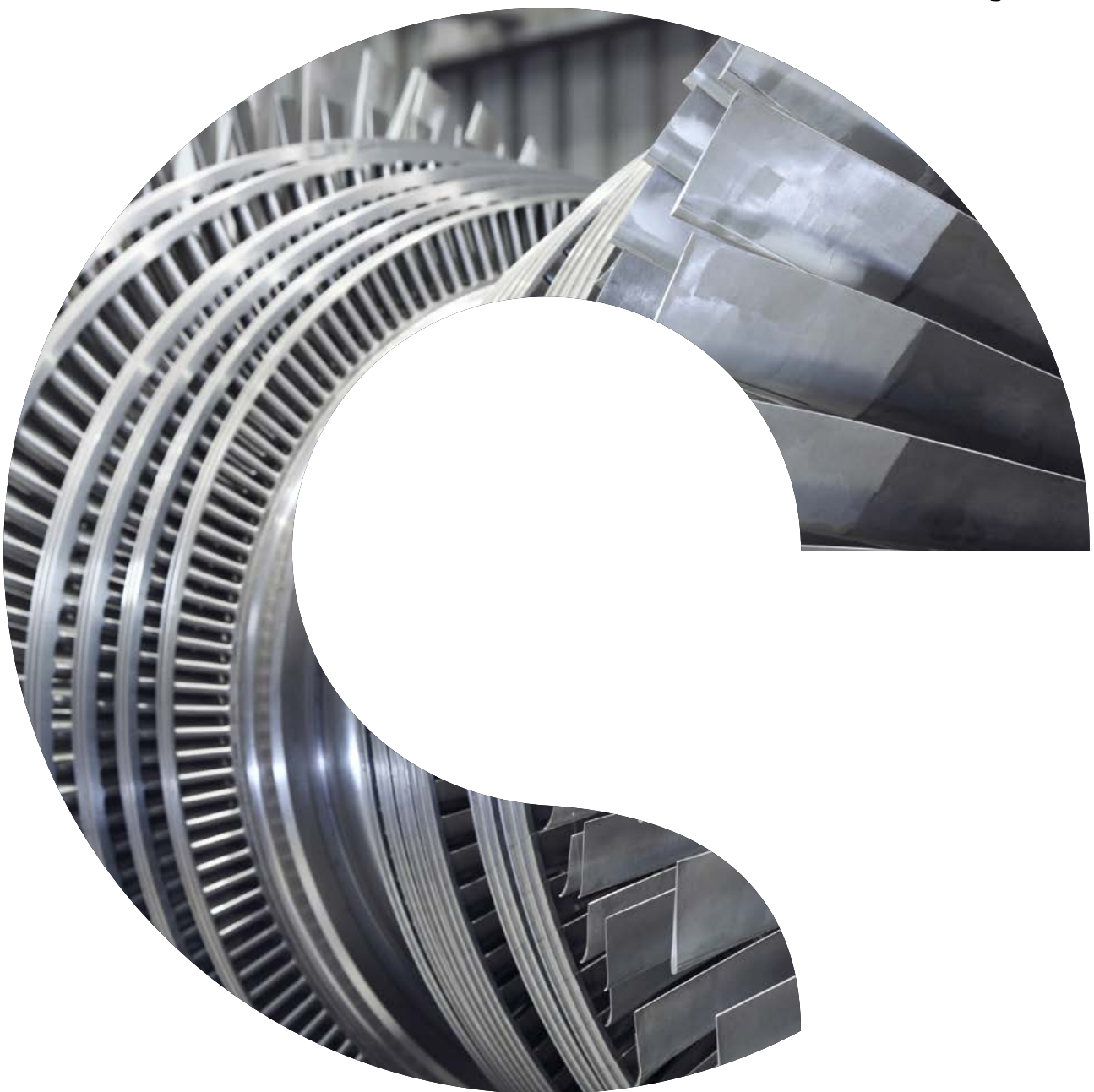

Flexibility in thermal power plants

IMPRINT

STUDY

Flexibility in thermal power plants –
With a focus on existing coal-fired power plants

COMISSIONED BY:

Agora Energiewende
Anna-Louisa-Karsch-Straße 2
10178 Berlin | Germany
T +49 (0)30 700 14 35-000
F +49 (0)30 700 14 35-129
www.agora-energiewende.de
info@agora-energiewende.de

Project lead: Dimitri Pescia
dimitri.pescia@agora-energiewende.de
Proofreading: WordSolid, Berlin
Layout: oekom verlag, Munich
Cover image: istock.com/photosoup

STUDY BY:

Project management:
Prognos AG
Europäisches Zentrum für Wirtschaftsforschung
und Strategieberatung
Goethestraße 85
10623 Berlin

Contact:
F. Ess
Telephone: +41 (0)61 32 73-401
Email: florian.ess@prognos.com

F. Peter

Comparison of thermal power plant technology
(chapter 3) and Retrofit options to increase
flexibility of coal-fired power plants (chapter 4):
Fichtner GmbH & Co. KG
Sarweystrasse 3
70191 Stuttgart

Contact:
Dr. F. Klumpp
Telephone: +49 (0)711 89 95-401
Email: florian.klumpp@fichtner.de

115/04-S-2017/EN

Publication: June 2017

Please cite as:
Agora Energiewende (2017):
Flexibility in thermal power plants –
With a focus on existing coal-fired power plants

Preface

Dear readers,

Due to immense cost reductions over the last decades, wind and solar power are contributing more and more to the decarbonisation of power systems around the globe. However, given their specific characteristics, these technologies fundamentally change electricity systems and markets. More variable power production increases the flexibility requirements placed on the overall power system, both on the supply and demand sides.

Often it is claimed that existing conventional power plants, especially coal power plants, cannot cope with the weather-dependent generation of wind and solar power. As a result, there is a rising level of renewable energy curtailment in some power systems. However, this report shows that making existing power plants more flexible is technically and economically

feasible. Since flexibility (rather than baseload generation) is the paradigm that shapes modern power systems, increasing the flexibility of existing coal and gas power plants should be partially understood as necessary for bringing them up-to-date.

Flexibility does not make coal clean, but making existing coal-fired plants more flexible enables the integration of more wind and solar power in the system. In the mid- to long-term, coal power plants will be replaced by clean solutions like storage technologies that provide power when the wind and sun are scarce.

I hope you find this report inspiring!

Yours sincerely,

Patrick Graichen

Executive Director of Agora Energiewende

Key Findings at a Glance

1

Existing thermal power plants can provide much more flexibility than often assumed, as experience in Germany and Denmark shows. Coal-fired power plants are in most cases less flexible compared to gas-fired generation units. But as Germany and Denmark demonstrate, aging hard coal fired power plants (and even some lignite-fired power plants) are already today providing large operational flexibility. They are adjusting their output on a 15-minute basis (intraday market) and even on a 5-minute basis (balancing market) to variation in renewable generation and demand.

2

Numerous technical possibilities exist to increase the flexibility of existing coal power plants. Improving the technical flexibility usually does not impair the efficiency of a plant, but it puts more strain on components, reducing their lifetime. Targeted retrofit measures have been implemented in practice on existing power plants, leading to higher ramp rates, lower minimum loads and shorter start-up times. Operating a plant flexibly increases operation and maintenance costs—however, these increases are small compared to the fuel savings associated with higher shares of renewable generation in the system.

3

Flexible coal is not clean, but making existing coal plants more flexible enables the integration of more wind and solar power in the system. However, when gas is competing with coal, carbon pricing remains necessary to achieve a net reduction in CO₂. In some power systems, especially when gas is competing against coal, the flexible operation of coal power plants can lead to increased CO₂ emissions. In those systems, an effective climate policy (e.g. carbon pricing) remains a key precondition for achieving a net reduction in CO₂ emissions.

4

In order to fully tap the flexibility potential of coal and gas power plants, it is crucial to adapt power markets. Proper price signals give incentives for the flexible operation of thermal power plants. Thus, the introduction of short-term electricity markets and the adjustment of balancing power arrangements are important measures for remunerating flexibility.

Content

Policy Summary

prognos

FICHTNER

Agora
Energiewende



11

WORK PACKAGE 1:
by Prognos AG

prognos

1. Introduction and background	21
2. The Effects of Expanded Renewables on Conventional Generation	23
2.1 Increasing requirements for flexible operation	23
2.2 The impact of renewables on the cost and utilisation of existing thermal power plants	26
2.3 The Merit-Order Effect	27
2.4 Balancing power	28
2.5 Congestion management and renewables curtailment	29

WORK PACKAGE 2:
by Fichtner GmbH & Co. KG

FICHTNER

3 Thermal power plant technology – Flexibility and comparison of generation technologies	33
3.1 Fundamentals of thermal power plant design and operation	34
3.2 Operational flexibility	42
3.3 Comparison of flexibility parameters in different generation technologies	46
4. Retrofits to increase flexibility of coal-fired power plants – Options, potential and limitations	57
4.1 Key components for flexibility retrofits	58
4.2 Trade-offs between flexibility and efficiency	74
4.3 Potential and limitations of flexibility retrofits	76

WORK PACKAGE 3:
by Prognos AG

prognos

5. The Impact of Flexibility on Power Plant Profitability and CO₂ Emissions	83
5.1 Flexibility impacts on power plant operations	83
5.2 Effects on CO ₂ emissions	88
5.3 Market design requirements to enhance the flexible operation of thermal power plants	94
<hr/>	
6. Profiles for Selected Countries: South Africa & Poland	99
6.1 South Africa	99
6.2 Poland	104
<hr/>	
7. Conclusion	109
<hr/>	
8. Bibliography	111
<hr/>	

Index of figures

Figure S1: Power generation from nuclear, hard coal and lignite power plants and demand in Germany, 23 to 30 March 2016	12
Figure S2: Qualitative representation of key flexibility parameters of a power plant	12
Figure S3: Minimum load and ramp rates of different hard coal power plants	13
Figure S4: Ramp rates and start-up times of different power plant technologies	13
Figure S5: Illustrative profit margin of a coal power plant in a short-term market with high shares of renewables under different flexibility and must-run conditions	16
Figure 1: Flexibility requirements with high share of renewables. Example load curves for two weeks during the winter in Germany.	24
Figure 2: Sorted hourly load change with and without the impact of renewable energy in Germany. Example load curves for two weeks during winter in Germany.	24
Figure 3: Conventional power generation in Germany during ten days in November 2016	25
Figure 4: Decreasing power prices on the wholesale market due to increasing shares of renewable energy production (Merit-Order Effect)	27
Figure 5: Relationship between monthly wind generation and monthly redispatch volumes in Germany (Jan. 2013 – Oct. 2016)	29
Figure 6: Structure of Chapter 3	33
Figure 7: Energy conversion process for fuel-fired thermal power plants	34
Figure 8: Overview of thermal generation technologies by fuel type	36
Figure 9: Schematic view of a water-steam power process	37
Figure 10: Simplified representation of the state changes of water in a water-steam circuit	37
Figure 11: Schematic of a gas turbine in open cycle configurations	39
Figure 12: Schematic view of a combined cycle gas turbine configuration	40
Figure 13: Schematic view of steam extraction from a steam turbine providing heat to a district heating system	41
Figure 14: Overview of flexibility characteristics	42
Figure 15: Qualitative representation of a power plant load curve with key power variables	43
Figure 16: Net power for a simplified start-up from standstill until nominal operation	44
Figure 17: Qualitative depiction of a power plant load curve highlighting the ramp rate	45
Figure 18: Ramp rates and start-up times of thermal power plants in comparison	47
Figure 19: Comparison of power plants with most commonly used technologies and power plants with state-of-the-art technologies for each generation type with regard to minimum load (values based on Table 1)	50

Figure 20: Comparison of power plants with most commonly used technologies and power plants with state-of-the-art technologies for each generation type with regard to the average ramp rate (values based on Table 1)	50
Figure 21: Comparison of power plants with most commonly used technologies and power plants with state-of-the-art technologies for each generation type with regard to start-up time (hot <8 h) (values based on Table 1)	51
Figure 22: Comparison of power plants with most commonly used technologies and power plants with state-of-the-art technologies for each generation type with regard to start-up time (cold >48 h) (values based on Table 1)	52
Figure 23: Structure of Chapter 4	57
Figure 24: 20 subsystems in a coal-fired power plant	58
Figure 25: Schematic illustration of a boiler in a tower construction	59
Figure 26: Tangential firing burner configuration with 4 burners on one stage	60
Figure 27: Schematic illustration of coal supply to burner	62
Figure 28: Net grid feed-in for indirect (IF) and direct firing (DF) configurations	62
Figure 29: Coal mill and burner arrangement of a boiler in tangential firing configuration with four burner stages (single-mill operation)	63
Figure 30: Operation of four burner stages (left) in comparison to a single burner stage in single-mill mode (right)	64
Figure 31: Load curves for pre-retrofit and post-retrofit of Unit G and H at Weisweiler	65
Figure 32: Charging a thermal energy storage system and its influence on net power fed into the grid	67
Figure 33: Simplified illustration of a coal-fired power plant with a gas turbine employed for feed water pre-heating	68
Figure 34: Basic principle of BoilerMax application	69
Figure 35: Comparison of two start-ups at Zolling, one with BoilerMax and one without BoilerMax	70
Figure 36: Influence of repowering on net power and ramp rate	72
Figure 37: Influence of relative pressure on allowable temperature change rate in K/min for a high pressure header designed with two different materials	73
Figure 38: Relationship between operating point and plant efficiency	74
Figure 39: Major coal-fired plant subsystems where retrofits were performed to improve flexibility	79
Figure 40: Hard coal power plant operation before and after retrofitting with lower minimum load, increased ramp rates and reduced start-up time in a 48-hour example period	85
Figure 41: Hard coal power plant in must-run operation in a 48 hour example period	85
Figure 42: Hard coal power plant with temporary shut-down in a 48 hour example period	86
Figure 43: Hard coal power plant with lowered minimum load and increased ramp rates in must-run operation in a 48 hour example period	86

Figure 44: Hard coal power plant with lowered minimum load and increased ramp rates and shorter start-up time in a 48 hour example period	88
Figure 45: Relationship between plant output and efficiency of hard coal and CCGT gas power plants (600 MW nominal power) at different operating points (illustrative)	90
Figure 46: CCGT operation versus hard-coal plant operation in a 48 hour example period	91
Figure 47: CO ₂ emissions of CCGT and hard coal power plants under similar dispatch conditions but with different flexibility features during 2 example days	92
Figure 48: Main challenges for the remuneration of flexibility	95
Figure 49: Balancing demand due to schedule leaps (hourly and quarter hourly)	96
Figure 50: Average balancing demand in Germany for each 15 minutes interval of the day in 2012 to 2015	97
Figure 51: Power generation in South Africa by source, 1990–2014	100
Figure 52: Power supply in South Africa by source, 2014	101
Figure 53: Age distribution of coal power plants in South Africa	102
Figure 54: Technical performance of coal power plants in South Africa	102
Figure 55: Ramp rates in comparison	103
Figure 56: Power generation in Poland by source, 1990 to 2014	105
Figure 57: Power generation in Poland by source, 2014, in TWh	105
Figure 58: Age distribution of coal and lignite fired power stations in Poland	107
Figure 59: Unit size distribution for Polish coal and lignite fired power stations	107

Index of tables

Table S1:	Summary of some retrofit options, their effect on flexibility parameters and their limitations	14
Table 1:	Comparison of most commonly used and state-of-the-art power plants for each generation technology with regard to flexibility	48
Table 2:	Comparison of three state-of-the-art coal-fired power plants in Poland and Germany	53
Table 3:	Net efficiency and specific CO ₂ emissions for the most commonly used generation technologies at nominal operation	54
Table 4:	Net efficiency and specific CO ₂ emissions for state-of-the-art generation technologies at nominal operation	54
Table 5:	Summary of analysed retrofit options, their effect on flexibility parameters and their limitations	76
Table 6:	Potential and limitations of retrofit options for reducing minimum load	77
Table 7:	Potential and limitations of retrofit options for reducing start-up time	78
Table 8:	Potential and limitations of retrofit options for increasing ramp rate	78
Table 9:	Plant parameters and market environment for the following illustrative examples	84
Table 10:	Specific CO ₂ emissions for a range of fuels	89
Table 11:	CO ₂ emissions for CCGT and hard coal fired power stations in different operational modes (data from Figure 47)	92

Policy Summary

The goal of limiting global warming to well below to 2°C can only be achieved if energy systems are almost completely decarbonised over the long run. Renewable energies, especially wind and solar PV, are playing a fundamental role to reach this goal. They have witnessed rapid expansion in power systems worldwide thanks to the immense cost reductions of the last decade. Because of their variable output and zero marginal generation costs, these technologies alter the characteristics of electricity systems and markets. Steeper and more variable residual loads increase the flexibility requirements placed on the overall power system, both on the supply and demand sides.

In several countries the development of renewable energy is hampered after reaching a certain penetration level, because of the belief that the existing power system cannot cope with the weather-dependent generation of wind and solar power. As a result, renewable energy curtailment has been on the rise in various power systems, with priority given to baseload operation of conventional generation technologies. While it is true that conventional power systems were not built to adjust to quickly changing patterns on the supply side, system operators around the world have learned to apply different flexible resources that complement growing shares of variable renewable energy. There are many potential sources of flexibility, including cross-border energy trading, demand side management, storage technologies, flexible biomass/biogas, and the flexible operation of conventional generation technologies, like gas and coal.

Regarding coal-fired power plants, it is widely assumed that they cannot be operated to flexibly adapt to varying system loads without costly redesign measures or losses in efficiency. However, the contrary is the case, as we show in this report. In actual fact, augmenting the flexibility of conventional power plants represents a major strategy for

effectively integrating large shares of renewables. This is especially true in systems characterised by few other flexibility options and/or very high shares of existing inflexible power plants, for instance in Poland and South Africa. In those countries, existing conventional power plants will continue to play a role during the transition to a deeply decarbonised power system. However, the generation output of these power plants will need to adjust to the generation of variable renewables.

In the long run, however, fossil-fuel power plants, especially coal-fired plants, will need to be replaced altogether with less CO₂ intensive technologies if international emission-reduction targets are to be met.

1. Existing coal power plants can technically provide much more flexibility than many think, as shown by experiences in countries like Germany and Denmark.

In countries like Germany, hard coal-fired power plants, and to some extent lignite-fired power plants, are already providing significant operational flexibility, adjusting their output to variation in renewable energy feed-in and demand (see figure 1).

At the power plant level, operational flexibility is characterised by three main features: the overall bandwidth of operation (ranging between minimum and maximum load), the speed at which net power feed-in can be adjusted (ramp rate), and the time required to attain stable operation when starting up from standstill (start-up time) (see figure 2).

State-of-the-art power plants have significantly improved flexibility characteristics. As illustrated in Figure S3 (left), state-of-the-art hard coal power plants can operate at minimum load levels

of 25–40 percent of nominal load. State-of-the-art lignite power plants can achieve minimum loads of 35–50 percent of nominal load. By contrast, power plants built ten to twenty years ago in industrialised countries had minimum load levels of 40 percent (hard coal) to 60 percent (lignite). Retrofitting can reduce minimum loads even further; in Germany, for example, minimum load levels of 12 percent have been achieved. Older coal power plants designed

mainly for baseload operation, especially in countries like China or India, can have much higher minimum load levels, significantly limiting the bandwidth of their operation. The ramp rate of state-of-the-art coal power plants (hard coal and lignite) can reach 6 percent of nominal load per minute, equalling or exceeding the ramp rate of the most-common CCGTs. The ramp rate of the most-common hard coal power plants in industrial countries is significantly lower,

Power generation from nuclear, hard coal and lignite power plants and demand in Germany, 23 to 30 March 2016

Figure S1

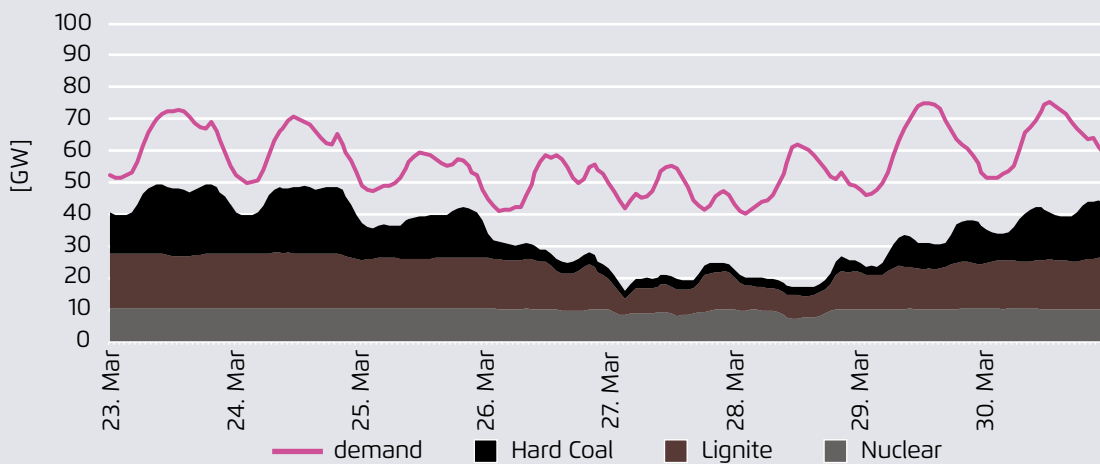

Agora Energiewende (2017)

Qualitative representation of key flexibility parameters of a power plant

Figure S2

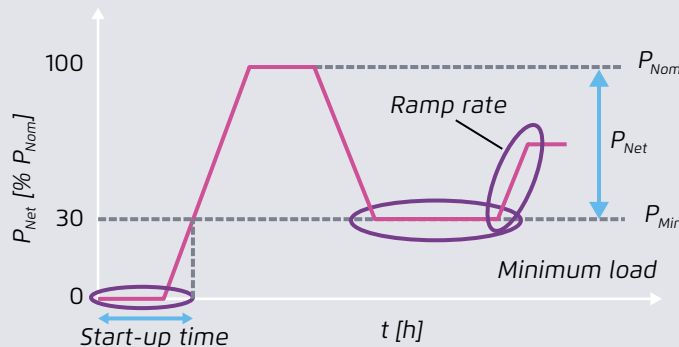

Fichtner (2017)

as can be seen in figure 3 (right). The same is true of old coal power plants in countries like South Africa, where the ramp rates per minute usually do not exceed 1 percent per minute. Start-up times, both hot and cold, are also significantly reduced in state-of-the-art designs.

Even though the flexibility features of state-of-the-art coal power plants are significantly better than those of older power plants, it must be pointed out that coal-fired power plants are in general less flexible than gas-fired generation units, especially in regard to start-up times and ramp rates.

Minimum load and ramp rates of different hard coal power plants

Figure S3

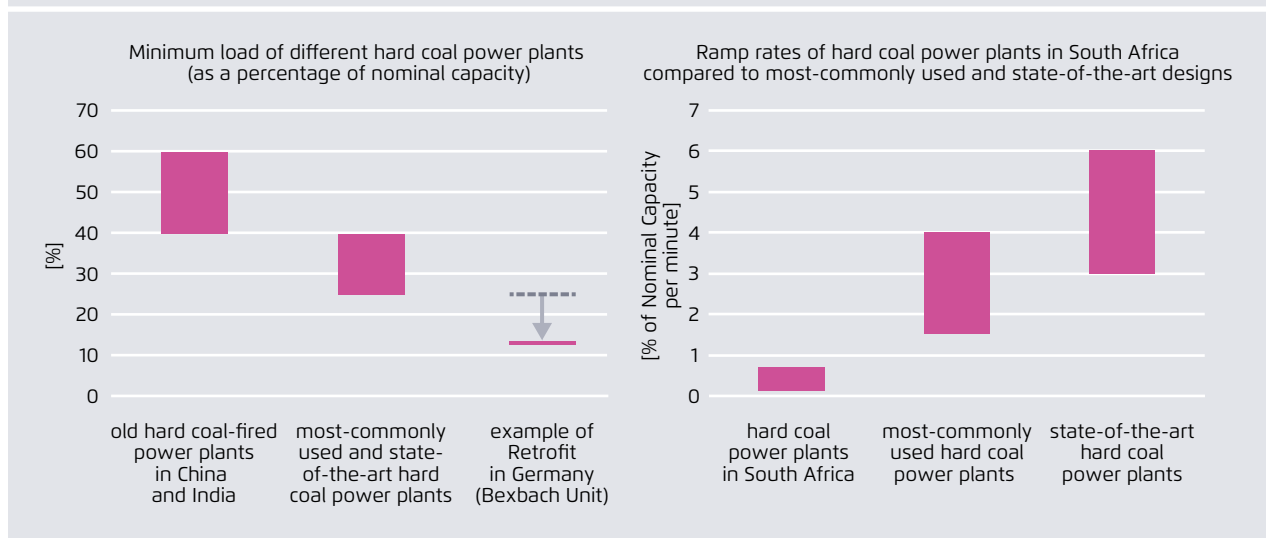

DEA, NREL, Fichtner (left), Prognos, Fichtner (right)

Ramp rates and start-up times of different power plant technologies

Figure S4

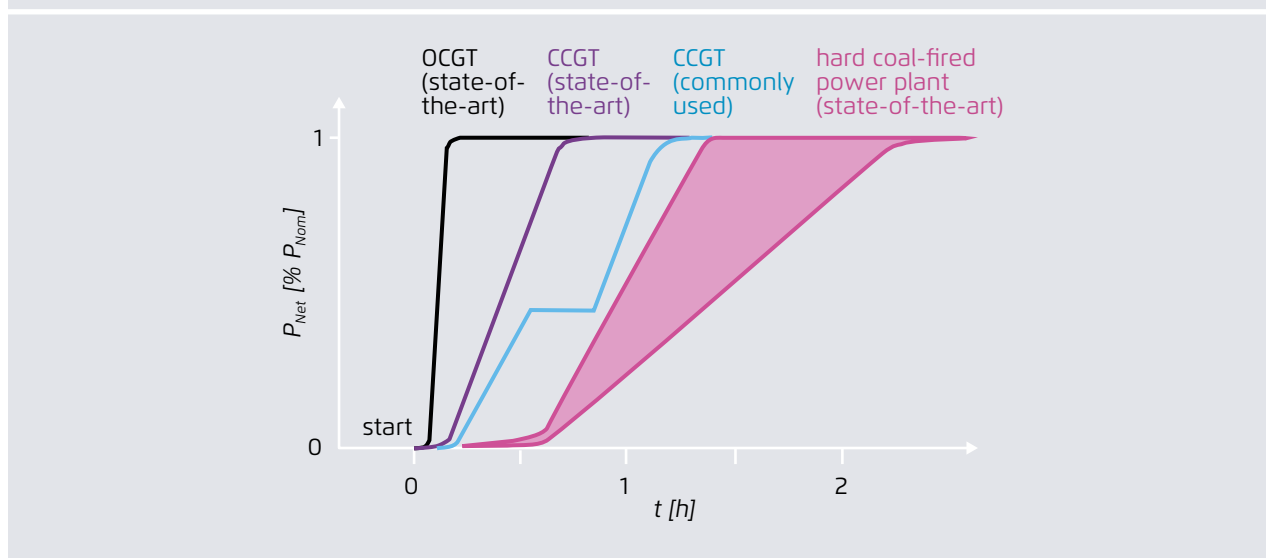

Fichtner (2017) based on (VDE, 2012)

2. Numerous technical possibilities exist to increase the flexibility of existing coal power plants. Improving the technical flexibility usually does not impair the efficiency of a plant, but it puts more strain on components, reducing their lifetime.

Targeted retrofit measures have been implemented in practice on existing power plants, leading to higher ramp rates, lower minimum loads, and shorter start-up times (see table S1). Important enabling factors for success include also the adoption of alternate operation practices as well as rigorous inspection and training programs. Reducing minimum load levels has proven to bring the most benefits, as it

helps to incorporate higher shares of renewables into the power system. Retrofitting measures have been successfully implemented even in older power plants, significantly enhancing their technical flexibility. For example, engineering and control system upgrades at the Weisweiler hard coal power plant in Germany allowed the minimum load levels of the two 600 MW generation units to be reduced by 170 MW (Unit G) and 110 MW (Unit H). This retrofit also had a positive effect on the ramp rate, which was increased by 10 MW/min. The retrofit cost about 60 million euros per generation unit. At the Bexbach hard coal power plant (721 MW), the minimum load was reduced from 170 MW (22% of P_{Nom}) to 90 MW (11% of P_{Nom}) by switching from two mill to single mill operation. Boiler fire stability and the allowable thermal stress on components are the two main limitations to improved flexibility. Nevertheless, as the

Summary of analysed retrofit options, their effect on flexibility parameters and their limitations Table S1

Option	Minimum load	Start-up time	Ramp rate	Limitations
Indirect Firing	✓		✓	Fire stability
Switching from two-mill to single-mill operation	✓			Water-steam circuit
Control system and plant engineering upgrade	✓		✓	Fire stability/ thermal stress
Auxiliary firing with dried lignite ignition burner	✓		✓	Fire stability and boiler design
Thermal energy storage for feed water pre-heating	✓			N/A
Repowering		✓	✓	N/A
Optimized control system		✓		Thermal stress
Thin-walled components/special turbine design		✓		Mechanical and thermal stresses
“New” turbine start		✓		Turbine design
Reducing wall thickness of key components			✓	Mechanical and thermal stresses

Fichtner (2017)

above examples show, meaningful improvements can be achieved.

The advanced age and limited operational flexibility of existing coal power plants are a key driver of modernisation measures. The net benefit of flexibility retrofitting depends on factors specific to the power plant and power system. Countries with large and aging coal-power fleets that were designed for baseload operation have a large upside potential for retrofit measures to increase efficiency and flexibility. Improving the technical flexibility of a power plant usually does not come at the expense of lower efficiency or higher CO₂ emissions. In many cases—for example, when pre-cast gas turbines are used—flexibility measures can even improve the efficiency of a coal-fired power station.

The investment costs required for flexibility retrofitting must be considered specifically on a case-by-case. They can be roughly estimated at 100 to 500 €/kW (as the examples in chapter 4 show). Retrofitting usually increases the technical lifetime of a power plant by about 10–15 years.¹ In comparison, overnight construction costs for new coal fired power stations with lifetimes of more than 40 years range between 1,200 €/kW to more than 3,000 €/kW if CCS technology is implemented.²

Flexible operation reduces the lifetime of a power plant. Thick-walled components are especially affected by thermal stress, which is exacerbated by higher ramp rates and multiple start-ups. Model calculations indicate that the lifetime of an old coal power plant is substantially decreased when subjected to flexible operation. In Germany, some power plant operators deliberately push the flexibility limits

of their power plants, taking into account reduced plant lifetimes. Flexibility can also increase operation and maintenance costs. From a system perspective, however, these increased costs are relatively small compared to the fuel savings associated with higher shares of renewable generation in the system.

3. Flexible coal is not clean, but making existing coal plants more flexible enables the integration of more wind and solar power in the system. However, when gas is competing with coal, carbon pricing remains necessary to achieve a net reduction in CO₂.

Power system effects are complex and the flexible operation of coal power plants without carbon constraints can, in some particular scenarios, increase CO₂ emissions. In principle, the flexible operation of coal power plants can have two conflicting effects on CO₂ emissions. On the one hand, the flexible operation of a coal-fired power plant can reduce its overall CO₂ emissions, since the plant generally produces less electricity over the year. On the other hand, lowering the minimum load through retrofit measures can reduce the efficiency of a power plant at low load levels, increasing the specific CO₂ emissions. (This effect is mitigated, however, by avoidance of expensive and CO₂-intensive shutdown and start-up).

A comprehensive assessment of a power plant's CO₂ emissions must take into account characteristic market and dispatch conditions as well as complete operation cycles, without focusing only on the lowest operating points. A comprehensive perspective reveals that in many systems the benefits of greater flexibility outweighs the CO₂ emission drawbacks of low load operation, especially when one considers the expanded deployment of renewables in the system.

However, in markets with a mixed portfolio of coal power plants and other lower emission technologies

1 See NREL 2012: Cost-Benefit Analysis of Flexibility Retrofits for Coal and Gas-Fueled Power Plants, <http://www.nrel.gov/docs/fy14osti/60862.pdf>

2 See Fraunhofer ISI et al: Estimating energy system costs of sectoral RES and EE targets in the context of energy and climate targets for 2030, http://www.isi.fraunhofer.de/isi-wAssets/docs/x/en/projects/REScost2030-Background-Report-10-2014_clean.pdf

such as natural gas, coal retrofits improve the competitive position of coal plants compared to other technologies. In such systems, increasing the flexibility of coal-fired power plants can have a negative impact on CO₂ emissions at the plant level. Therefore, the goal of limiting CO₂ emissions in the power sector must be addressed with effective CO₂ abatement policy.

Increased plant-level CO₂ emissions after retrofitting can occur, for example, if partial load operation prevents the coal-fired power plant from shutting down during periods of non-profitable operation (however, this drawback is mitigated by avoidance of CO₂-intensive start-up). In such a case, the coal-fired power plant stays in the market due to its improved competitive position compared to less CO₂-intensive gas plants. This has a negative impact on overall CO₂ emissions – unless the plant is a must-run plant that would have stayed operational anyway in order to provide system services. In this latter case, which is likely in a system with very high share of coal, more flexible operation will generally have a signif-

icantly positive effect on the overall emissions of the power plant fleet.

It is also important to state that, under similar dispatch conditions, flexible coal power plants emit more CO₂ per MWh of electricity compared to gas power plant generation, even when taking into account the lifecycle emissions of the fuels.

4. In order to fully tap the flexibility potential of thermal power plants, it is crucial to adapt power markets.

The economics of retrofitting existing coal power plants are significantly influenced by the availability of remuneration options for flexibility. In other words, a market design that hampers investment in flexibility constrains the appropriate retrofitting of coal power plants (not to mention the investment in alternative flexibility options). Proper price signals should remunerate the flexible operation of thermal power plants. In short-term markets with a high share of renewables, the profit margins earned by

Illustrative profit margin of a coal power plant in a short-term market with high shares of renewables under different flexibility and must-run conditions

Figure S5

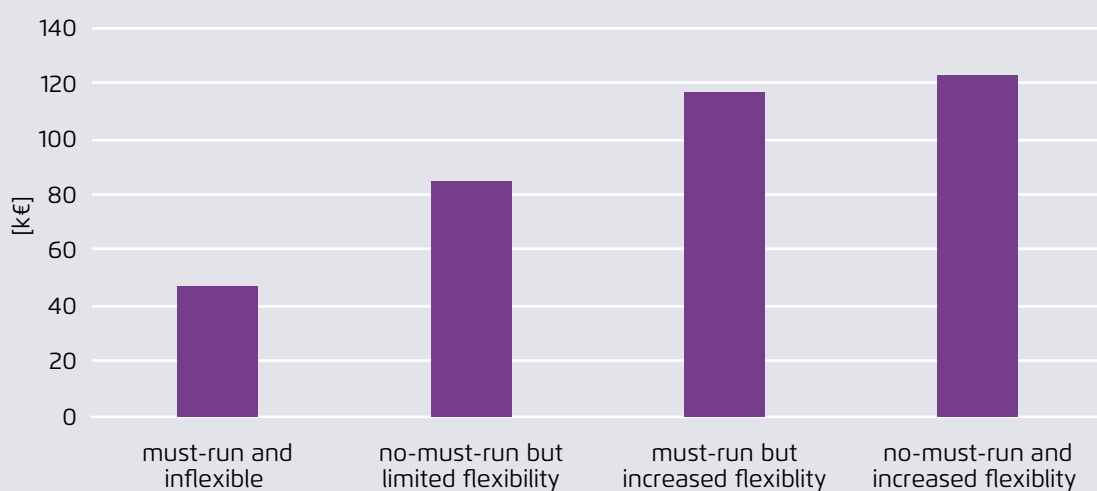

Prognos, Agora Energiewende (2017)

flexible coal-fired power plants can be significantly improved. To some extent, this can offset losses suffered because of reduced utilisation (as a consequence of the expansion of renewables). Indeed, reduced minimum load is in many cases key for shoring up profitability.

Whether and to what extent flexibility retrofitting measures are profitable varies on a case-by-case basis in relation to plant characteristics and the market environment (e.g. age of the plant, market share of renewables, general market design, remuneration options for flexibility). However, experience in Germany shows that when the market is properly designed to remunerate flexibility, flexibility retrofitting is likely to be profitable.

With high shares of renewable power generation, electricity markets should be designed to support market actors that provide valuable flexibility options. Necessary measures include the introduction of shorter-term electricity markets and products

(e.g. intraday trading) as well as the adjustment of balancing power arrangements. With these changes, integrating renewables into the power system becomes easier and more economically efficient, and wasteful renewable energy curtailment is avoided.

In this way, improving the operational flexibility of coal power plants can, together with other flexibility measures, support the expansion of renewables during the transition toward a decarbonised power system. A crucial determinant of the need to retrofit coal power plants is the availability of alternative flexibility options, including other flexible conventional generation (gas, flexible hydro), demand-side flexibility and cross-border energy trading. The quality and availability of these options varies considerable between countries due to structural, economic, and geographic factors. However, in countries with power sectors dominated by coal, improving the operational flexibility of coal power is an important and highly viable option for bolstering the adoption of renewables.

Effects of Expanded Renewables on Conventional Generation

WORK PACKAGE 1

WRITTEN BY

Prognos AG
Europäisches Zentrum für Wirtschaftsforschung
und Strategieberatung
Goethestraße 25
10623 Berlin
Telephone: +49 (0)30 52 00 59-200
Fax: +49 (0)30 52 00 59-201
www.prognos.com

Contributing authors:

F. Ess
Telephone: +41 (0)61 32 73-401
Email: florian.ess@prognos.com

F. Peter

prognos 

1. Introduction and background

The basis for international climate policy changed significantly with the adoption of the Paris Agreement in December 2015. The goal of limiting global warming to well below to 2°C can only be achieved if energy systems are almost completely decarbonised over the long term. The decarbonisation of the power system is essential in this regard, as fossil fuels remain the dominant source of power generation worldwide, and are responsible for a large share of global greenhouse gas emissions. Renewable energy such as wind power and solar photovoltaic are playing a fundamental role in the transformation of the power system. These technologies have experienced tremendous cost reductions in recent years and are becoming cost-competitive with conventional technologies for new investment. However, renewables are characterized by variable and uncertain output, increasing the need for flexibility in the power system. Indeed, enhancing supply and demand-side flexibility will be crucial for integrating higher shares of renewables in a cost-efficient and reliable way.

This study addresses an important concern that is typically raised when discussing power systems with a high share of renewables. Once the development of renewables reaches a certain level, concerns grow that existing conventional power plants cannot be operated with sufficient flexibility. As a result, there are calls to limit the addition of new fluctuating renewable capacity to the system. One clear problem that is connected to this issue is the high level of renewable energy curtailment that occurs in certain power systems – for example, in some provinces in China, where priority is given to conventional baseload generation.

Making existing conventional power plants more flexible is therefore a key prerequisite for integrating large shares of renewables more effectively. This is especially true in systems characterized by few other flexibility options and/or very high shares of

existing inflexible power plants, especially coal-fired plants.

Historically, conventional generation capacities were built to follow rather predictable electricity demand patterns. This paradigm favoured the construction of a mix of generation resources dominated by largely inflexible power plants, operating as baseload power (more than 80 percent of the year) and fired by lignite, hard coal or nuclear energy. Today, the priority given to these inflexible power plants has become a major force curbing the development of renewables, especially in countries that rely on large share of coal power production (such as South Africa and Poland). In these countries, existing conventional power plants will continue to play a role during the transition toward a fully decarbonised power system. However, the generation output of these power plants will need to adjust to the generation of variable renewables.

Existing coal power plants can technically provide much more flexibility than many think, as this report will show. In countries like Germany and Denmark, targeted retrofit-measures have been implemented on existing power plants, significantly enhancing their technical flexibility. Furthermore, effective market incentives – including intraday electricity markets – have been introduced in order to remunerate the provisioning of flexibility. Such measures have enabled renewable generation to be integrated more easily and in an economically efficient way, thus limiting wasteful curtailment.

Together with other flexibility measures, improving the flexibility of thermal power plants can enable higher shares of renewable production during the transition to a decarbonised power system. In the long run, however, fossil-fuel power plants, especially coal power plants, will need to be replaced altogether with less CO₂ intensive technologies if international climate targets are to be met.

The main aim of this study is to provide a broad analysis on possible flexibility measures for thermal power generation while focusing on coal power plants. In doing so, we consider technical and economic factors related to increasing the flexibility of conventional power plants.³ The study is divided in four parts: The first part analyses major challenges related to the integration of large shares of renewables. The second part describes in detail current

technical characteristics related to the flexibility of thermal power plants. The third part analyses some retrofit measures to increase the flexibility of coal power plants, including their technical and economic parameters. Fourth, our findings with regard to challenges and opportunities are discussed and put into perspective by spotlighting the situation in South Africa and Poland, two countries with large coal power generation shares.

³ Note that the flexibility challenge of combined heat and power plants (CHP) is not addressed in detail in this report. Brief information on this topic can be found in section 3.1.5.

2. The Effects of Expanded Renewables on Conventional Generation

An increasing share of variable renewable energy such as wind and PV has a direct impact on the operation of conventional power plants. Conventional power plants need to operate more flexibly, meaning they have to ramp up and down more frequently and more quickly, operate often at partial loads and have to be turned on and off with greater regularity. Moreover, a rising share of renewables also decreases the market profitability of conventional generation due to the so-called Merit-Order Effect. In addition, it has indirect impacts on conventional power plants, as it increases the demand for balancing and congestion management in the power system.

2.1 Increasing requirements for flexible operation

In a power system characterised by increasing shares of renewable power generation, the flexibility requirements placed on existing conventional capacities rise significantly. The main cause of an increased need for flexibility is the variable nature of power generation from wind power and photovoltaics (PV). Both technologies depend on weather conditions, daily and seasonal changes, and therefore cannot generate "on demand" like conventional power plants. Furthermore, renewables have almost no marginal costs. This means that they produce "for free" whenever the primary resource (i.e. wind or sun) is available. These factors entail a fundamental transformation of power systems, because of the need to respond flexibly to variation in renewables feed-in.

Several options currently exist to provide more system flexibility for the integration of renewables. Encouraging demand-side flexibility (e.g. more flexible manufacturing processes) is one option. Another is to promote grid development, so that power can be transported with greater ease between regions and

countries. A third option is to store electricity using conventional storage technologies (e.g. hydro storage) or new technologies (e.g. batteries). Last but not least, increasing power plant flexibility make a key contribution to greater system flexibility, and, by extension, promote the integration of renewables.

Historically, conventional power plants have been designed to serve electricity demand pattern that is characterized by relatively low variability as well as prototypical daily, weekly and seasonal profiles. In the absence of variable renewables, this leads to an optimal generation mix with a high share of baseload power plants (i.e. running more than 80 percent of the year). However, renewable generation is highly variable, and to some extent less predictable. With a high share of variable renewables, a large proportion of conventional generation can no longer operate as baseload capacity and must be run with greater flexibility.

The need for flexibility and the challenges faced by conventional power plants are illustrated in Figure 1. The left side of the figure (a) shows the hourly structure of electricity demand (load) over two weeks. On the right side (b) the same two weeks are plotted – but with an annual share of 40 percent renewables in the system. This "residual load" profile is derived by subtracting hourly renewable generation from hourly electricity demand.

In a system with no variable renewables, conventional power plants serve demand based on the load curve (see figure 1a). In systems with high shares of wind and PV, conventional plants must serve the load not covered by variable renewables, i.e. the residual load curve. Therefore, their operation has to be significantly more flexible (figure 1b). Whereas the load only ranges between 47 and 84 GW in a sys-

Flexibility requirements with high share of renewables. Example load curves for two weeks during the winter in Germany.

Figure 1

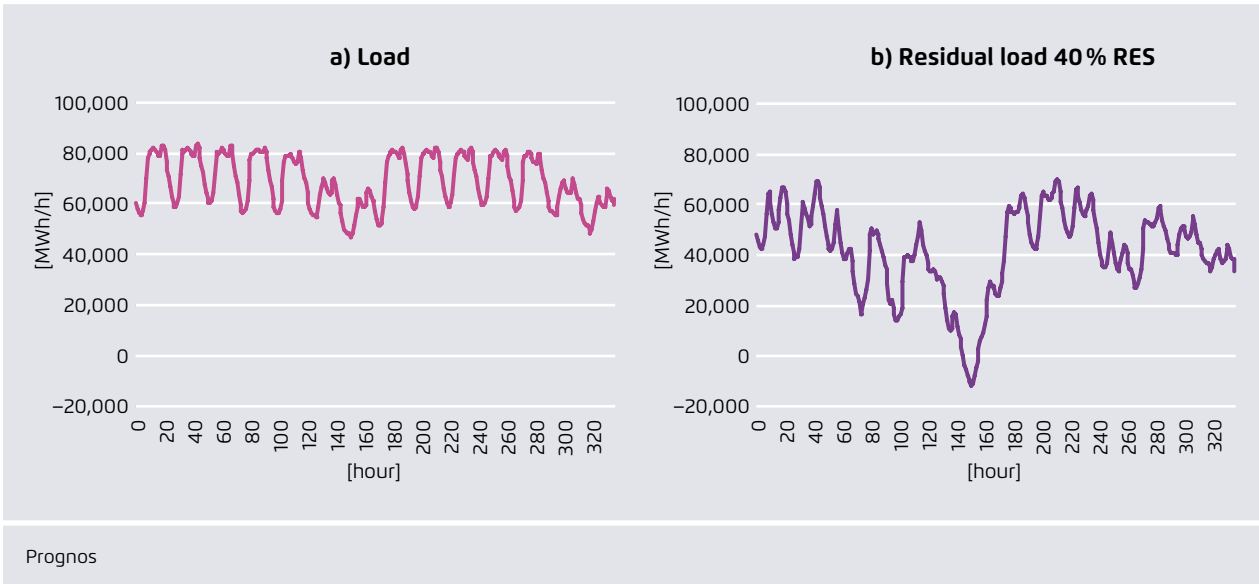

Sorted hourly load change with and without the impact of renewable energy in Germany. Example load curves for two weeks during winter in Germany.

Figure 2

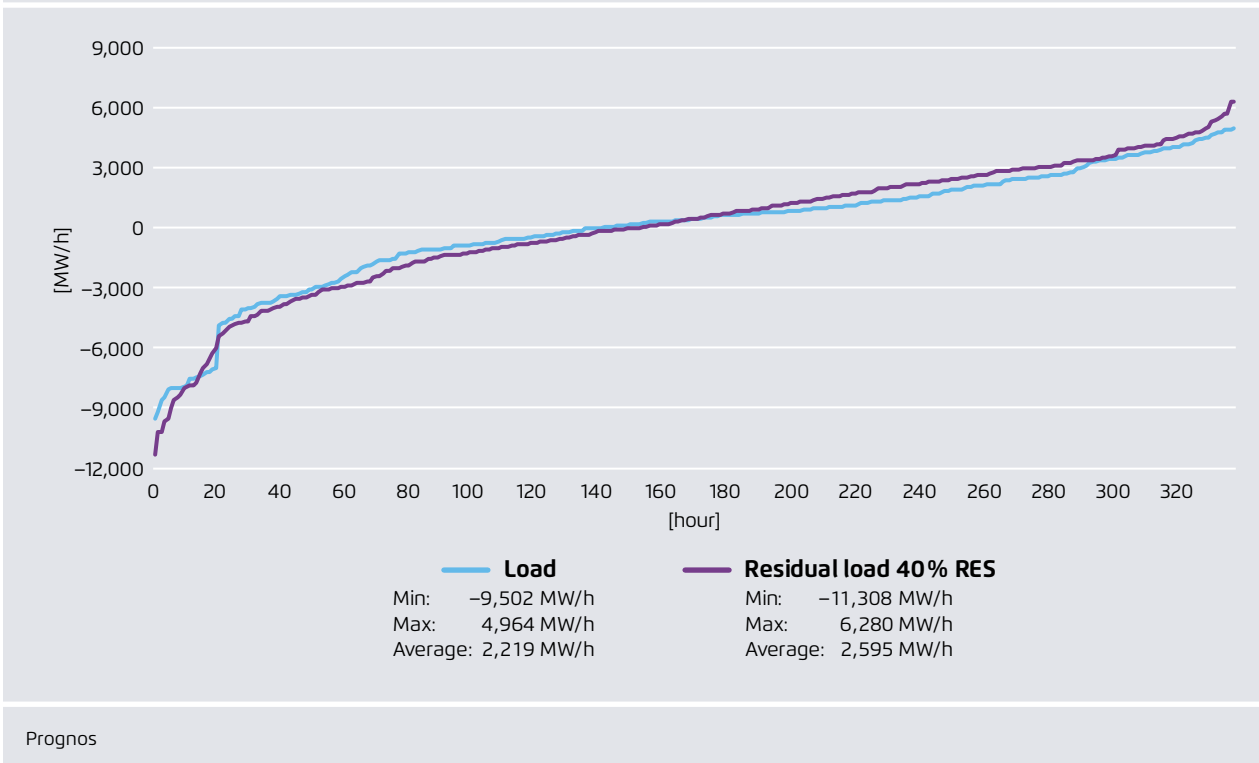

Conventional power generation in Germany during ten days in November 2016

Figure 3

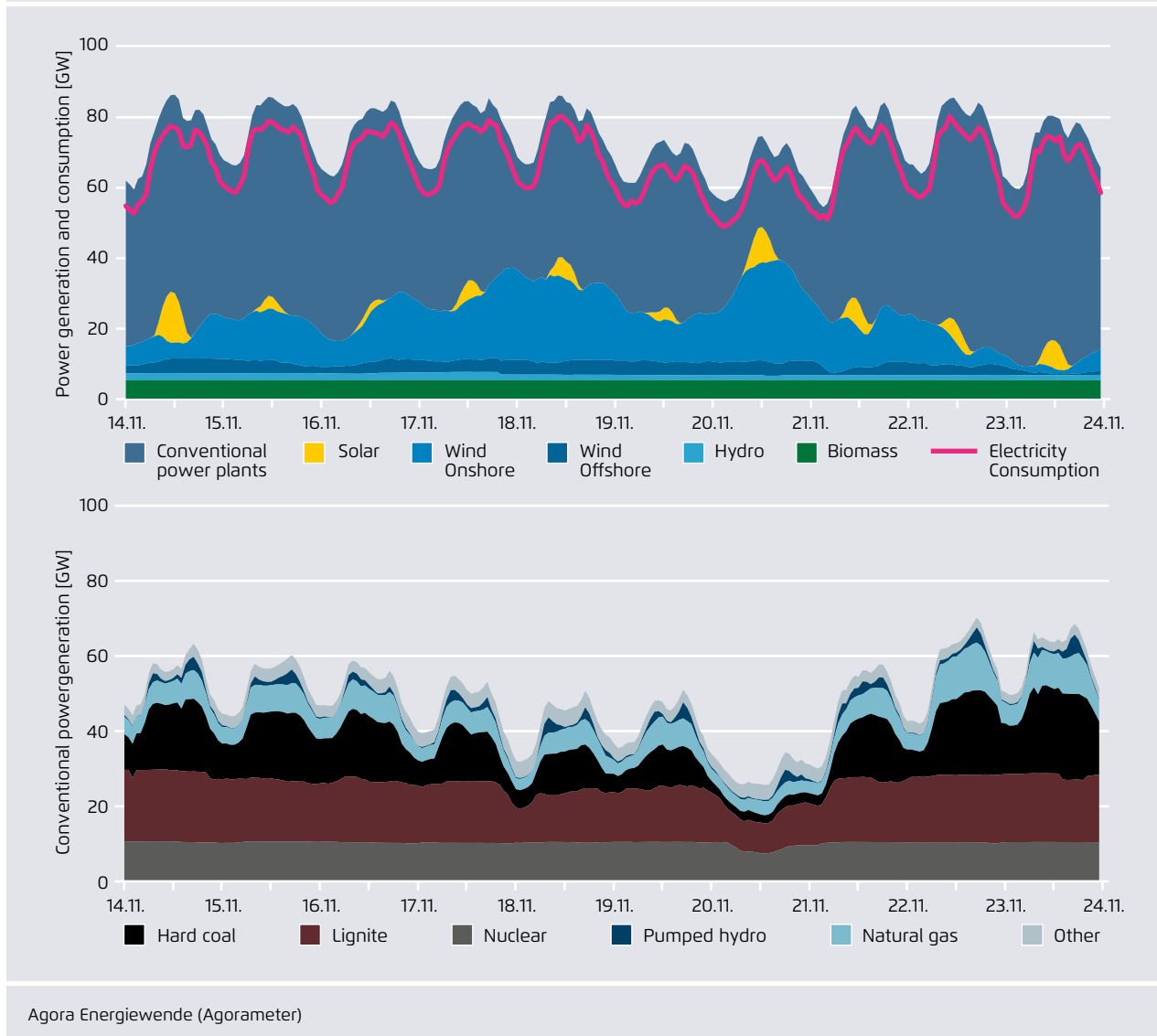

tem without renewables during these two example weeks, in a system with 40 percent variable renewables, the residual load can fall to minus 12 GW (due to temporary surpluses from renewable generation) and rise to 70 GW within few days. Residual-load ramp rates (i.e. load changes in one or more consecutive hours) are also considerably higher than the variations in electricity demand. Figure 2 shows in greater detail the hourly load changes during the two example weeks. The addition of intermittent renewables leads to a significant change in both the mini-

mum and maximum hourly load changes (Figure 2). In our example, the overall average hourly load change increases from 2,219 MW per hour to 2,595 MW per hour. This represents an increase of about 17 percent. If intermittent renewable shares reach even greater levels, the observed load changes will also increase accordingly.

The German power system provides a good example on how conventional power generation can adjust output in a power system characterised by

considerable amounts of renewable generation.⁴ Figure 3 illustrates power generation in Germany during 10 days in November 2016, which includes high feed-in from wind power during the weekend of November 20–21.

As can be seen in figure 3, conventional power generation from gas power plants as well as hard-coal and lignite plants declines significantly when there is high renewable feed-in (and low power demand). In this example, the flexible operation of conventional power plants enables the integration of large amounts of renewables, especially on November 20, when both wind energy and solar PV contribute to up to 60 percent of power demand during a few hours.

This study examines the following flexibility factors for conventional power plants in a system with a significant share of renewables:

- **Ramp rates:** Because load variations in the residual load are larger than variations in electricity demand (load), conventional power plants have to be faster in adjusting their generation over the course of one or more consecutive hours.
- **Minimum load:** Renewable generation during one hour can amount to nearly 100 percent of demand, even if shares of renewable generation are much lower over the whole year. Therefore, conventional generation must adjust to lower operating thresholds than are adequate in a system without a significant share of renewables.
- **Start-up times:** At certain times it is necessary (and economically beneficial) for conventional power plants to shut down temporarily. Start-up times after such a shut-down are another crucial factor that determine the flexibility of conventional power generation.

2.2 The impact of renewables on the cost and utilisation of existing thermal power plants

In addition to imposing the need for greater flexibility, the increasing integration of variable renewables has economic impacts both on the utilisation of conventional power plants and their profitability. The flexible operation of coal power plants is technically possible (as will be shown in the following sections), yet reducing the utilisation of capital-intensive technology has negative impacts on profitability. However, these impacts can be mitigated with a properly functioning market (see sections 5.1 and 5.3).

In general, when additional capacity is introduced to a power system – whether wind, solar, or any other type of power plant – the output and revenues of other power plants tend to be reduced. In contrast to thermal power plants, however, wind and solar power plants produce electricity only if the wind blows or the sun shines. This means that their output is variable and does not react to changes in demand for electricity. This has two important implications for the utilisation of existing conventional power plants:

- First, the structure of residual demand (defined as demand minus renewables feed-in) is changed, leading to a change in the use of existing power plants. In the long run, this also produces a change in the cost-optimal mix of residual power plants. This is often described as a shift from “base load” to “mid-merit and peak load”.
- Second, conventional thermal power plants may still be needed in the system, in order to provide capacity during times of high demand, particularly when the wind is not blowing and sun is not shining. This is often described as a need for “backup capacity”, or alternatively as the need for thermal capacity with reduced average utilisation.

These two factors impact the fixed costs and variable costs of the thermal power plants in the system.

⁴ In 2016, variable renewables (wind energy and solar PV) accounted for 18% of power consumption in Germany.

Decreasing power prices on the wholesale market due to increasing shares of renewable energy production (Merit-Order Effect)

Figure 4

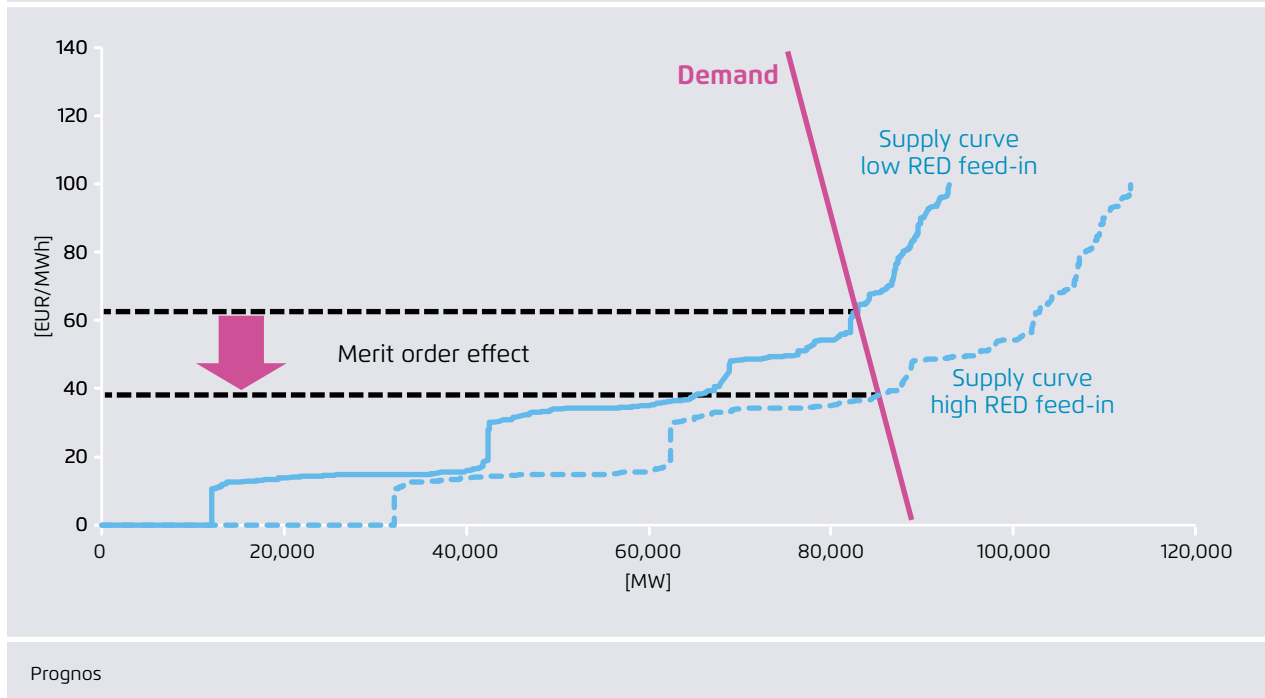

The reduced average utilisation of the thermal power plants leads to higher specific generation costs (EUR/MWh). This effect is particularly important for generation technologies that are capital intensive, like coal-fuelled power plants. Coal and lignite are a highly available and low cost energy source in many countries in the world. In those countries, low fuel costs in combination with rather inflexible power plants, designed for baseload operation, increase the benefits of inflexible operation. When intermittent renewables are incorporated into such a system, the likely response is to simply curtail renewable generation when feed-in is very high.

2.3 The Merit-Order Effect

Beyond impacting the utilisation of thermal power plants (as discussed above), renewables also impact power plant earning in the wholesale market due to the so-called Merit-Order Effect.

In liberalised markets, the power prices on the wholesale market are determined by supply and demand. Typically, wholesale markets are organised using auctions as pay-as-clear markets.⁵ To calculate the market clearing price, the supply curve (merit order) is first sorted in an ascending order by means of the variable costs of the power supply units (see figure 4). The variable costs are determined by different factors, such as fuel prices, CO₂ costs and opportunity costs. Nuclear and lignite power plants typically have low variable costs, while hard coal and new CCGT have medium variable costs. OCGT and oil power plants have the highest variable costs. In a second step, the market clearing price is determined by the intersection of the supply and demand curves.

In contrast to thermal power stations, wind and PV have no variable costs. Therefore, renewable energies

⁵ In contrast to pay-as-bid markets, each successful bidder gets/pays the same price.

integrate at the beginning of the merit order, pushing conventional technologies further out on the merit order. This has two effects: on the one hand, the utilisation rate of power plants tends to decrease – especially during times of high renewable energy production and low demand (as explained in 2.2). On the other hand, the average market clearing price decreases as more expensive technologies are less frequently employed. This crowding out effect is termed the Merit-Order Effect. Both effects decrease the profitability of thermal power plants on the wholesale market.

In Germany and other markets, the increasing penetration rate of renewable energy in combination with low fuel and emission costs and surplus of production capacities have placed significant pressure on conventional generation assets during the past years. Several power stations have been forced to shut down.

2.4 Balancing power

Renewable generation, being weather-dependent, is subject to forecasting errors. Forecasting errors increase the need for maintaining and activating balancing reserves, and can therefore increase balancing costs. Other factors, however, can decrease balancing costs, partially offsetting the cost impact of increased renewables (for example, more competitive balancing markets, better forecasts, liquid intraday markets, better cooperation between TSOs, etc.). Balancing power is necessary to guarantee the frequency stability of electrical grids by balancing in real-time power generation and consumption. If the power system is undersupplied, positive control power has to be added, whereas negative control power has to be activated if the system is oversupplied.

The causes of balancing power demand are various. In systems without renewable generation, the primary causes are unplanned power plant outages, load forecasting errors and load noise. In systems with variable renewables, errors in forecasting wind and PV production must be added to the list. (In most

systems, power plant dispatch takes place well ahead of real-time, increasing weather forecasting errors).

The magnitude of forecasting error depends on the quality of the forecasting methods and the time horizon for which the forecast is made. While forecasting errors are likely to be significant when made over a period of several hours or days, they are likely to be close to zero if made for a period less than an hour. Furthermore, the relative size of the deviation is also likely to decline with a greater geographical distribution of renewable power plants.

Other factors also influence balancing demand, such as schedule leaps (see subsection 5.3) and the size of the balancing area.

The impact of these factors can be observed in the German balancing system. Yet despite increasing energy generation from wind and PV, balancing demand has not increased. This is primarily attributable to the efficiency savings that have been achieved with the introduction of the International Grid Control Cooperation, which increased the balancing area. In addition, the impact of scheduling leaps was reduced by strengthening the trading of quarter-hour power contracts.

To evaluate the cost of integrating renewable energy, both the demand and supply side have to be taken into consideration. The market entry of new participants and technologies (thanks to eased prequalification requirements as well as financial pressures from decreased wholesale market revenues) have recently reduced balancing costs in the German market.

In power systems with mostly thermal plants, balancing costs are estimated at between 0 and 6 EUR/MWh, even at wind penetration rates of up to 40 percent. In power systems with significant shares of flexible hydro generation, such as the Nordic region, balancing costs are even lower.⁶

⁶ See Agora Energiewende (2015).

2.5 Congestion management and renewables curtailment

The German experience shows that the expansion of variable renewables changes power flows in the grid, which can impact the operation of conventional power plants.

The production of wind and PV power is location-specific. Typically, wind turbines and PV panels are installed in regions with high wind speeds and solar radiation. Often these renewable generation centres are geographically distant from where power is actually consumed. As wind and solar radiation cannot be stored and transported directly like coal or natural gas, the renewable power has to be transmitted. However, the expansion of the transmission and distribution grid has lagged behind the expansion of renewable capacities. To avoid short-term grid con-

gestion, network operators employ various measures. These include network switching, countertrading, redispatch⁷ of conventional power plants and the curtailment of renewable energy production.

In countries with priority feed-in for renewable energy, curtailment of renewables generation is by law the last option to be chosen. In these countries, redispatch regimes, in which network operators request power plants to adjust their production, are usually the favoured solution. This requires power plants to be flexible enough to come back to their schedule after the redispatch, in order to avoid creating new imbalances to the system..

⁷ In the event of a redispatch request to conventional power plants, the asset before the network congestion has to shorten its power generation, whereas a different power plant after the bottleneck balances the shortage by increasing power generation.

Relationship between monthly wind generation and monthly redispatch volumes in Germany (Jan. 2013 – Oct. 2016)

Figure 5

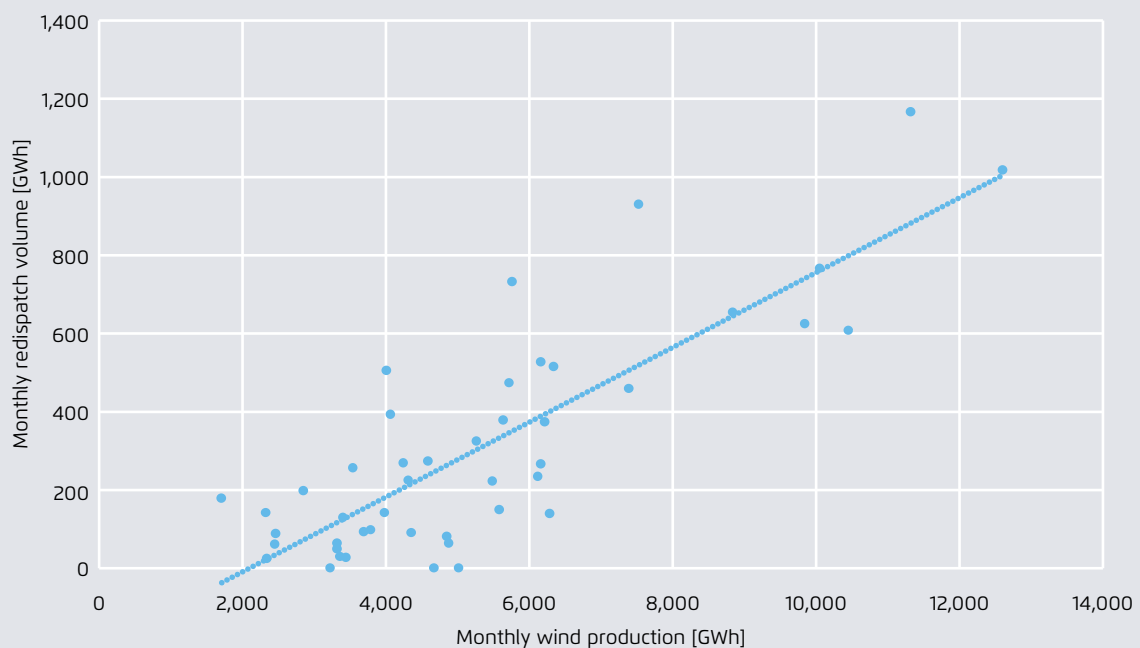

Prognos based on TSOs data (netztransparenz.de)

In other countries, the curtailment of renewables may be chosen as a first option, especially if the market design favours baseload operation of thermal generation (for example, through long-term contracts and priority access). This is, for example, the case in China, where about 15 percent of the total wind production was curtailed in 2015, with the level of curtailment even reaching 30–40 percent in some provinces, according to the Danish Energy Agency.

Figure 5 illustrates the relationship between wind energy production and redispatch volumes in the German markets. The figure clearly shows the impact of increasing wind energy production on redispatch volumes. Regional grid constraints are the main reason for increased redispatch volumes. This graph shows that without redispatch, monthly renewable curtailment could reach significantly high levels (up to 1 TWh in the most windy month).

All of the described effects associated with a large share of renewables lead to significant changes in the operation of conventional power plants. Fleets of power plants that are dominated by rather inflexible assets, i.e. that have been mainly designed for baseload operation, would prefer to see the curtailment of renewable energy as the key option for assuring system stability. However, this would substantially lower the CO₂ savings of increased RES shares, lead to higher system costs and limit the level of RES that can be incorporated into the system.

The following sections describe in detail the technical potential for increasing the flexibility of existing power plants. These options pave the way for the integration of larger shares of renewable energy, even when the conventional power plant fleet is dominated by coal and lignite stations that were installed mainly for baseload operation.

Comparison of thermal power plant technology and Retrofit options to increase flexibility of coal-fired power plants

WORK PACKAGE 2

WRITTEN BY

Fichtner GmbH & Co. KG
Sarweystrasse 3
70191 Stuttgart
Telephone: +49 (0)711 89 95-693
Fax: +49 (0)711 89 95-459
www.fichtner.de/

Contributing author:
Dr. Florian Klumpp
Telephone: +49 (0)711 89 95-401
Email: florian.ess@prognos.com

FICHTNER

3. Thermal power plant technology – Flexibility and comparison of generation technologies

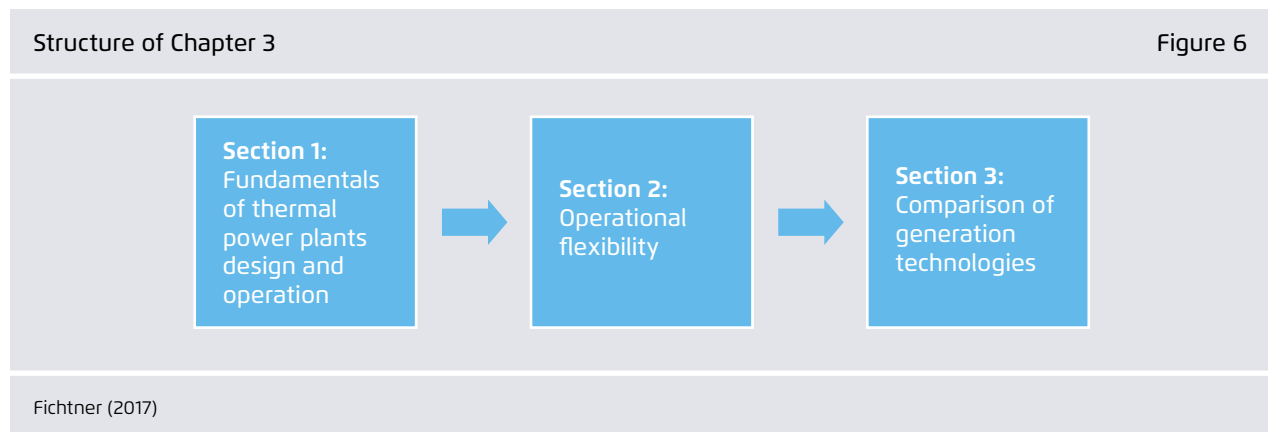

The following chapter is organized into three sections (Figure 6).

Section 1 explains the key terminology and underlying working principles of thermal power plants. It also provides an overview of pertinent generation technologies.

Section 2 introduces the concept of operational flexibility. The scope of the study encompasses three key parameters that characterize flexibility: minimum load, start-up time and ramp rate.⁸

Section 3 compares four relevant thermal generation technologies based on their flexibility parameters and CO₂ emissions: OCGT and CCGT gas-power plants, lignite-fired and hard coal-fired power plants. It also presents the characteristics of specific coal power plants.

⁸ Flexible operation can also be characterized by technical parameters such as fuel flexibility or black start capacity. (Fuel flexibility is the ability to burn a wide range of fuels with different properties. Black start capacity describes the ability of restarting a power plant without requiring the external grid). However, the relevance of such parameters are of secondary importance for assessing the overall flexibility of the power plants and were therefore not considered in this study.

3.1 Fundamentals of thermal power plant design and operation

The following fundamentals are necessary for understanding the basic operation of thermal power plants.

3.1.1 Definition of key terminology

To have a sound discussion about a topic as complex as power plant technology, it is important to provide a precise definition of the terminology.

Thermal power plant

A thermal power plant is characterized by an energy conversion process in which thermal energy (e.g. released during fuel combustion) is converted into electrical energy.

Figure 7 illustrates the energy conversion process for fuel-fired thermal power plants.

This figure shows the conversion of fuel in thermal power plants. Each type of energy conversion takes place in a main power plant component—the burner/

boiler, the turbine and the generator. Energy losses occur during each conversion step. Below is a brief description of the main steps, and where they occur within the power plant.

Burner/Boiler

Chemical energy stored in the fuel is converted into thermal energy via combustion.

Turbine

Thermal energy (gas or steam at high temperature and pressure) is converted into mechanical energy (torque on a shaft) through the expansion of the working fluid.

Generator

Mechanical energy is converted into electricity through electromagnetic induction.

Cooling tower/Exhaust

The second law of thermodynamics says that thermal energy cannot be fully converted into mechanical energy. The non-convertible part (energy) has to be released into the environment through a cooling tower or through exhaust.

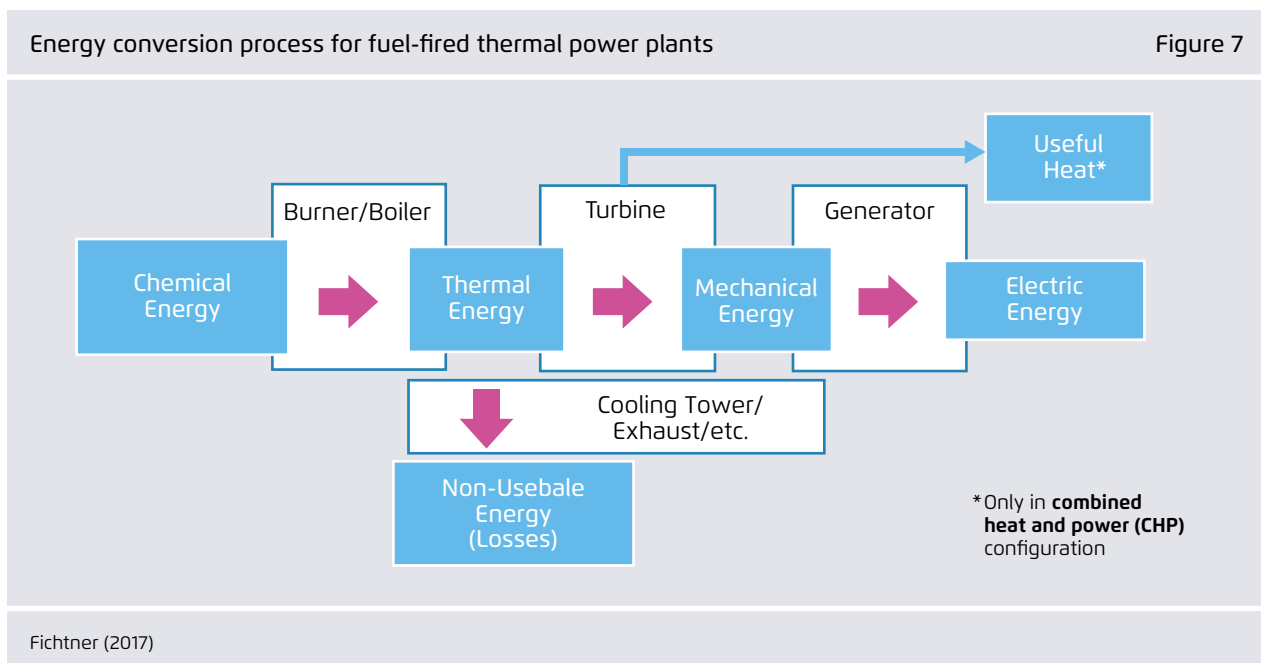

Cogeneration module (if in use)

Different power plant technologies offer different ways to cogenerate electricity and heat. For instance, heat can be used directly for some industrial processes or it can be fed into a district heating system. Section 3.1.5 explains this process in more detail.

Efficiency

In the context of thermal power plants, efficiency, usually denoted by the Greek symbol η , represents the share of the fuel's energy that is converted into electricity.

Alternatively, efficiency is formulated as a ratio between a system's beneficial output (e.g. net power P_{Net}) and its input (e.g. heat flow released through the combustion of fuel \dot{Q}_{In}):

$$\eta = \frac{P_{Net}}{\dot{Q}_{In}}$$

The net power is the power that is fed into the grid. It is defined as the generator power output, P_{Gen} (sometimes called gross output), minus the power required to drive auxiliary systems, P_{Aux} , such as pumps, fans and coal mills.

Efficiency is closely related to the CO₂ emissions of a thermal power plant. For a specific amount of generated electricity, usually denoted in MWh or GWh, less fuel is required when the power plant is operated at a higher efficiency, which also translates into lower specific CO₂ emissions. Typical efficiency values at nominal loads in thermal power plants vary between 39–60 percent, depending on type and age of the power plant.⁹ (This is described in detail in Section 3.3.2.)

⁹ The parameters of most commonly used generation technologies and state-of-the-art generation technologies are defined in Section 3.3.

Load

In the context of power plant operation, the net power, P_{Net} , is usually referred to as the load of a power plant.

Nominal load, also referred to as nameplate or nominal capacity, describes the highest consistent net power output of a power plant operating under design conditions. It is denoted by P_{Nom} for the remainder of this report.

Part load describes the operation of a power plant with a net power output that is lower than its nominal value.

Minimum load describes the lowest net power output a power plant can deliver while maintaining stable operation. It is denoted by P_{Min} for the remainder of this report.

Typically, power plants are optimized to have their highest efficiency at or close to their nominal load. When a power plant has to reduce its electricity generation, it is forced to operate under part load conditions, at a lower efficiency. This in turn leads to higher CO₂ emissions per MWh as described in Section 3.3.2.

3.1.2 Overview of thermal generation technologies

This report considers four main thermal generation technologies:

- **lignite-fired** power plants;
- **hard coal-fired** power plants;
- **open cycle gas turbine (OCGT)** power plants; and
- **combined cycle gas turbine (CCGT)** power plants.

As shown in Figure 8, fossil-fuelled power plants are separated by fuel types.

Coal is the leading fuel used in steam power plants. **Lignite** and **hard coal** need to be distinguished

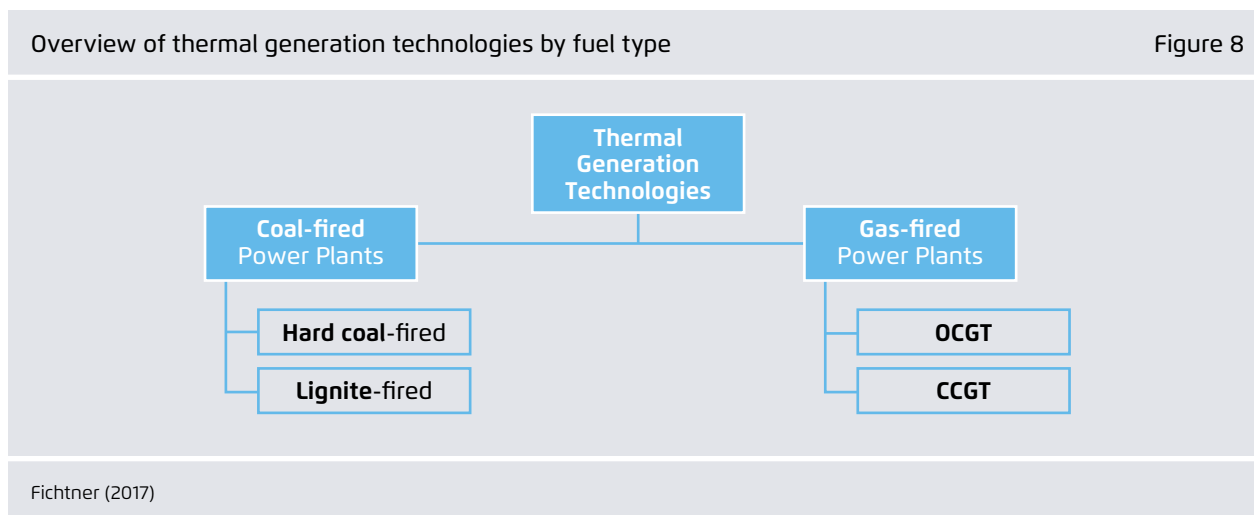

because they greatly influence the characteristics of a power plant's operation.

Natural gas, for the remainder of this report simply referred to as **gas**, is a fuel used in gas-fired power plants. Gas-fired power plants are characterized by their operation design, which can either be **open cycle** or **combined cycle**.

The next three sections analyse the working principles of coal-fired power plants (Section 3.1.3), gas-fired power plants (Section 3.1.4) and combined heat and power (CHP) plants (Section 3.1.5). Other generation technologies, such as internal combustion engines or nuclear power plants, are not analysed in this study.

3.1.3 Basic working principle of coal-fired power plants

The underlying working principle of steam turbine-driven power plants, such as coal-fired, nuclear or concentrated solar power plants, is the water-steam circuit. In thermodynamics, this is referred to as the *Rankine cycle*. It is a self-contained working cycle, which means that the working fluid (water) experiences different changes in its state but never leaves the cycle. Steam turbines generate mechanical torque through the expansion of high temperature and high pressure steam.

Figure 9 shows a schematic view of a general water-steam circuit. Its main components are the pump (1), the boiler (2), the turbine coupled with the generator (3) and the condenser (4).

The process can be broken down into four steps:

Step 1: Pressure increase

A pump increases liquid water pressure. Since water is nearly incompressible, its density undergoes virtually no change during this step.

Step 2: Heat addition through coal combustion

The boiler burns a mixture of air and fossil fuel, such as coal. The thermal energy released through this process is then transferred to the water, causing the water to evaporate and turning it into steam. After all the water has been evaporated, the steam continues to be heated in a process known as superheating. This increases the temperature and specific volume of the steam.

Step 3: Expansion in the turbine

After the heat is added, steam expands in the turbine. The reactive forces of the expanding fluid are used to drive the turbine. This process is driven by a significant pressure difference between the turbine inlet and outlet. At the turbine outlet, both

Schematic view of a water-steam power process

Figure 9

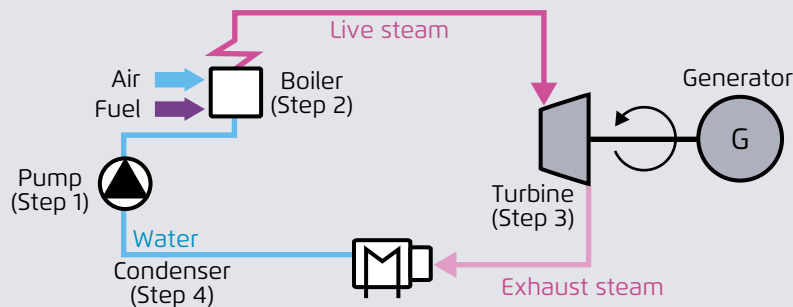

Fichtner (2017)

pressure and temperature of the steam decrease significantly.

Step 4: Condensation

Since a steam turbine process is a closed cycle, a fourth step is necessary to bring the working fluid back to its original liquid state. The non-convertible part of the thermal energy (anergy), contained in the steam after expansion, has to be released through condensation. During the condensation process, the

working fluid returns to its liquid state by releasing heat at a low temperature to a cooling medium, such as water from a nearby river.

After returning to its liquid state, the water continues the cycle and undergoes the above state changes on a continuous basis (1–4).

The figure 10 depicts the qualitative state changes of water in a water-steam cycle. The y-axis represents

Simplified representation of the state changes of water in a water-steam circuit

Figure 10

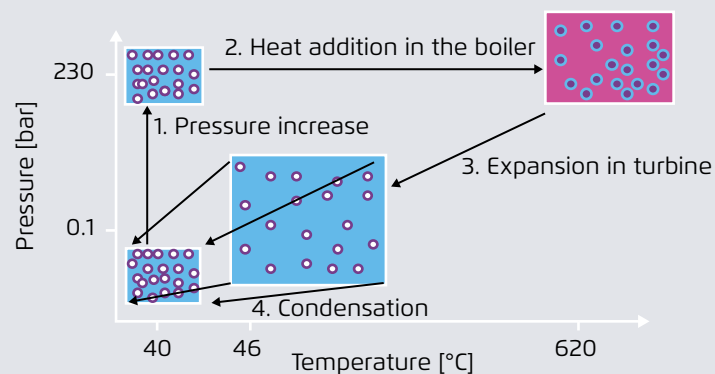

The small rectangles represent the water in a liquid state; the large rectangles, the water in steam state; the blue represents a state at lower temperature and the red a state at high temperature.

Fichtner (2017)

the working fluid pressure in bar, whereas the x-axis shows the temperature in degrees Celsius. The temperature after condensation mainly depends on the cooling medium employed.

Differentiation of subcritical, supercritical and ultra-supercritical water-steam circuits

Water-steam circuits can be operated below or above the critical point of water specified by its critical pressure and temperature ($p_c = 221,2$ bar; $T_c = 374,15$ °C). Three types of water-steam circuits exist and are differentiated based on their live steam parameters:

subcritical:	160 bar / 535 °C
supercritical:	240 bar / 540 °C
ultra-supercritical:	285 bar / 600 °C

Higher temperature and pressure during operation require advanced materials but also yield higher efficiencies.

Lignite- and hard coal-fired power plants

Both power plant types use a steam turbine cycle. The main difference is the coal type, which has significant implications on plant operation. State-of-the-art hard coal-fired units provide up to 900 MW, whereas state-of-the-art lignite-fired units reach up to 1,050 MW.

Lignite-fired

Lignite-fired power plants are typically designed to operate at nominal load for most hours of the year (i.e. baseload operation) and should only perform a few start-ups annually.

The high water content of lignite (45–60 percent), requires a pre-combustion drying procedure in the mills (beater-wheel mills). For this process, hot flue gas (up to 1,000 °C) is fed in.¹⁰

¹⁰ Flue gas describes the gas stream exhausted to the environment through a flue gas stack or chimney after a combustion process. For fossil-fired thermal power plants, the composition of the flue gas depends on the type and characteristics of fuel that is combusted and the combustion characteristics. The main constituents of flue gas are nitrogen (N_2), oxygen (O_2), water vapor (H_2O) and carbon dioxide (CO_2).

In comparison with hard coal, lignite's low energy density (about 8 MJ/kg) requires a larger boiler and flue gas cleaning equipment to reach a specific power output, leading to relatively long and cost-intensive start-up.

Due to the relatively low energy density of lignite, it is not economically feasible to transport it over long distances. Hence, lignite-fired power plants are usually constructed close to mining areas

Hard coal-fired

Hard coal-fired power plants show a greater flexibility than lignite-fired power plants. Their component dimensions are smaller, mainly due to larger energy density (about 25–32 MJ/kg) and lower water content (about 2–7 percent) relative to lignite.

Before the hard coal is blown into the boiler of the power plant it is finely grained in the bowl mills and dried with a hot air stream to reduce its water content.

3.1.4 Basic working principle of gas-fired power plants

The *Joule* cycle is the underlying working principle of gas-fired power plants. One distinguishes between **open cycle** and **combined cycle** configurations. Combined cycle gas turbines employ the *Joule* as well as the *Rankine* cycles (described in the previous Section 3.1.3).

1. Open cycle gas turbine (OCGT)

Gas turbines create mechanical torque by expanding a mixture of compressed air and flue gas at high pressure and temperature. In the open cycle configuration, the exhaust stream is released to the environment.

The open cycle gas turbine process is illustrated in Figure 11. The basic components are the compressor (1), combustion chamber (2) and the turbine coupled with the generator (3). Compressor, gas turbine and generator are mounted on a common shaft.

Schematic of a gas turbine in open cycle configurations

Figure 11

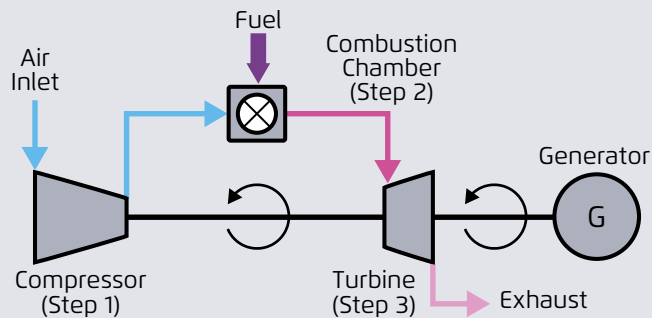

Fichtner (2017)

The process can be broken down into three steps:

Step 1: Compression

During operation, ambient air is sucked into the machine by the compressor and brought to a higher pressure level.

Step 2: Heat addition through gas combustion

The compressed air enters the combustion chamber and is mixed with the fuel (i.e. natural gas). The thermal energy released during combustion causes an increase in gas temperature and volume.

Step 3: Expansion in the turbine

The hot gas mixture expands in the turbine, which in turn exerts torque on the shaft.

Again, compressor, turbine and generator sit on a common shaft. In this way, the energy transmitted to the shaft by the turbine is used to turn both the generator and the compressor.

2. Combined cycle gas turbine (CCGT)

A combined cycle gas turbine (CCGT) uses the waste heat of the gas turbine exhaust to drive a water-steam circuit. Hence, a CCGT is a combination of a gas turbine and a steam turbine.

The components of a CCGT are similar to gas and steam turbine power plants. A heat recovery steam generator (HRSG) is used instead of an externally fired boiler. It transfers thermal energy from the exhaust gas of the gas turbine to the water of the steam turbine cycle. Figure 12 shows a schematic view of a CCGT.

The process can be broken down into three steps:

Step 1: OCGT process

For typical CCGT configurations, heat input only takes place during the *Joule* cycle through fuel combustion. The generated electricity in the gas turbine typically accounts for roughly two thirds of the total power generation of the CCGT.

Step 2: Heat transfer

In an OCGT process, the exhaust gas is released directly to the ambient air. In a CCGT, the thermal energy contained in the gas turbine exhaust is transferred to a water-steam cycle in a heat recovery steam generator (HRSG).

Step 3: Steam turbine process

The thermal energy from the exhaust gas is used to generate steam and operate the water-steam circuit. The turbines of the CCGT can have individual gener-

Schematic view of a combined cycle gas turbine configuration

Figure 12

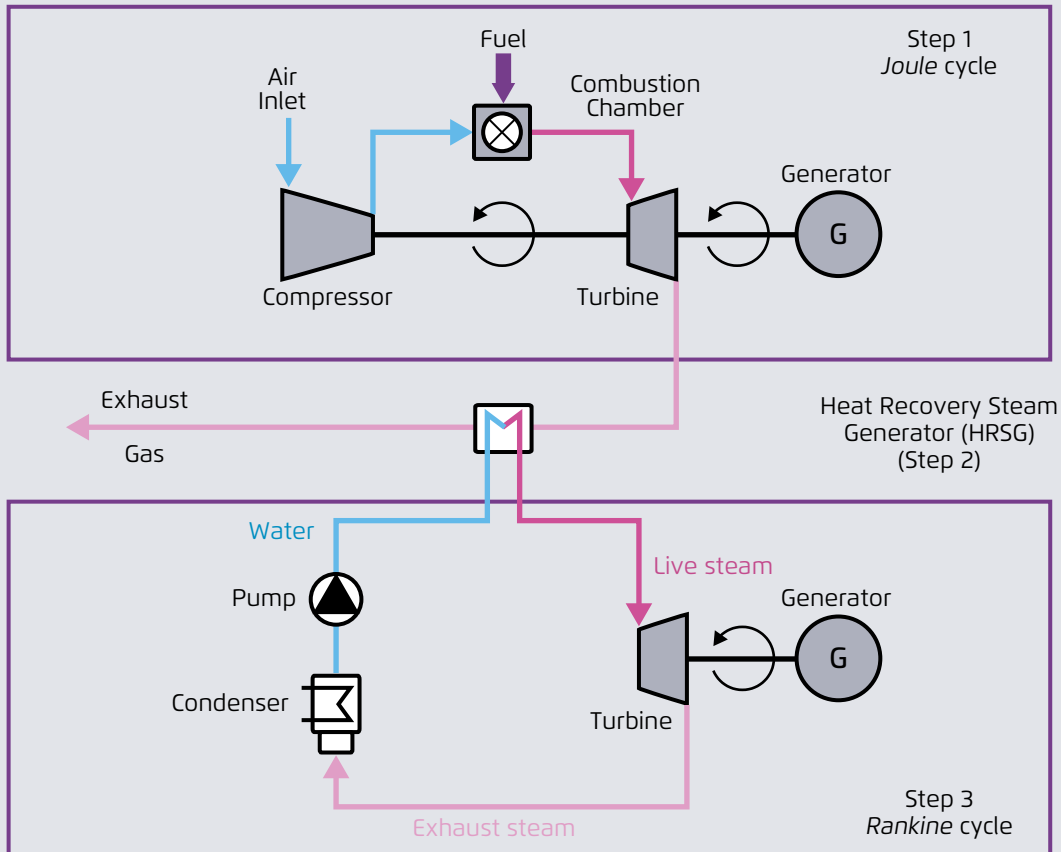

Fichtner (2017)

ators, as depicted in Figure 12, or drive a common one, referred to as a single shaft configuration. The steam turbine typically provides about a third of the total power generation of a CCGT power plant.

Gas-fired power plants

Gas-fired power plants are usually designed to provide medium to peak load to the grid, due to their relatively high level of flexibility and to their cost structure (low capital expenditure (CAPEX), high fuel cost). However, the operation may change in the future depending on fuel and CO₂ emission prices.

- OCGT are typically operated in pure peak load operation. Their efficiency reaches up to 40 percent, they display high fuel cost and they require very low CAPEX.
- CCGTs are typically operated at a medium load. Their efficiency reaches up to 60 percent, they have medium fuel costs and they require low CAPEX.

Both technologies (OCGT and CCGT) can also be operated in CHP mode.

3.1.5 Brief description of Combined Heat and Power (CHP)

Combined heat and power, also referred to as cogeneration, describes the simultaneous generation of electricity and useful heat. It significantly improves the overall utilization of fuel by substantially reducing the amount of waste heat.

In CHP plants, partially expanded steam at medium temperature is extracted from the steam turbine. The thermal energy in the steam is then transferred to another medium in a separate network, which supplies customers with heat either through district heating or for heat-intensive industrial processes (process heat).

Figure 13 shows a simplified schematic view of a district heating system supplied with heat from a water-steam circuit.

Theoretically, all thermal power plants can be operated in cogeneration mode. With OCGTs, a HRSG can be used to generate process heat using hot flue gases (up to 550 °C). CCGTs, hard coal-fired power plants and lignite-fired power plants have two options: extract steam from the steam

turbine or use a so-called back-pressure steam turbine.

In practice it is very common to operate CCGTs, hard coal-fired plants and lignite-fired plants in CHP mode in Germany for economic and environmental reasons. CHP operation depends on the existence of heat demand by, say, district heating or process heat.

According to the (AG Energiebilanzen, 2016), 17 percent of net electricity generation in Germany in 2015 was provided by cogeneration plants.¹¹ At today's industrial power plants (serving on-site consumption of electricity and heat), almost 75 percent of electricity is generated through gas-fired units. A OCGT in combination with a HRSG is commonly used when high temperature process heat is required.

Flexibility of cogeneration power plants

Typically, cogeneration plants are partly operated in a heat controlled mode. To ensure a constant supply of thermal energy to their customers, they are required to run at a certain load ("must-run capacity"), making them rather inflexible. This means that they are

¹¹ This value includes so-called mini-cogeneration facilities.

Schematic view of steam extraction from a steam turbine providing heat to a district heating system

Figure 13

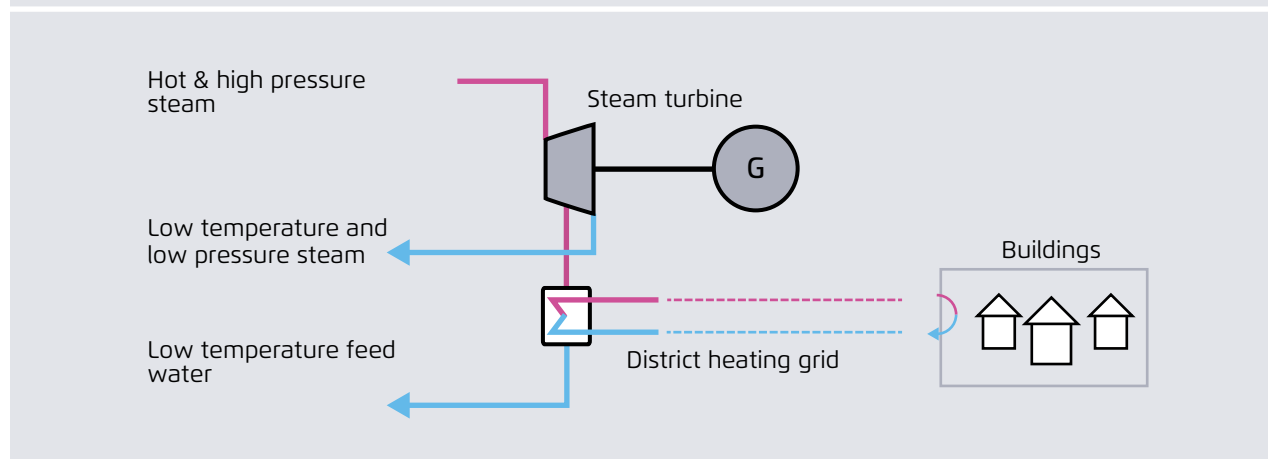

Fichtner (2017)

limited in responding to changing electrical power demands.

Large thermal energy storages can be used to reduce the inflexibility of CHP power plants. Heat production and consumption can be partly decoupled – in times of high renewable production, say. This allows the cogeneration plant to react flexibly to changes in power demand.

Typical capacities for thermal heat storages range from 20 MWh to 1,500 MWh and have storage volumes of 500 to 45,000 m³. The discharge duration of the different thermal energy storages vary by size and discharge capacity. For example, a large atmospheric thermal energy storage with a discharge capacity of 1,500 MWh and a water volume of 30,000 m³ has a discharge duration of about 6 hours (Kraft, 2015). This means that the power plant can in principle stop generation for up to 6 hours while providing a constant heat of 250 MW to its consumers through the discharge of its thermal storage.

3.2 Operational flexibility

The section discusses the concept of operational flexibility. For ease of reading, it is simply referred to as “flexibility” for the remainder of the report.

Flexibility

The flexibility of a power plant can be described as its ability to adjust the net power fed into the grid, its overall bandwidth of operation and the time required to attain stable operation when starting up from a standstill.

The key parameters characterizing the flexibility of a thermal power plant are illustrated in Figure 14:

Sections 3.2.1 to 3.2.3 below elaborate on each flexibility parameter. Section 3.2.4 describes the influence of flexible operation on the lifetime costs and on the operation and maintenance (O&M) costs of a thermal power plant.

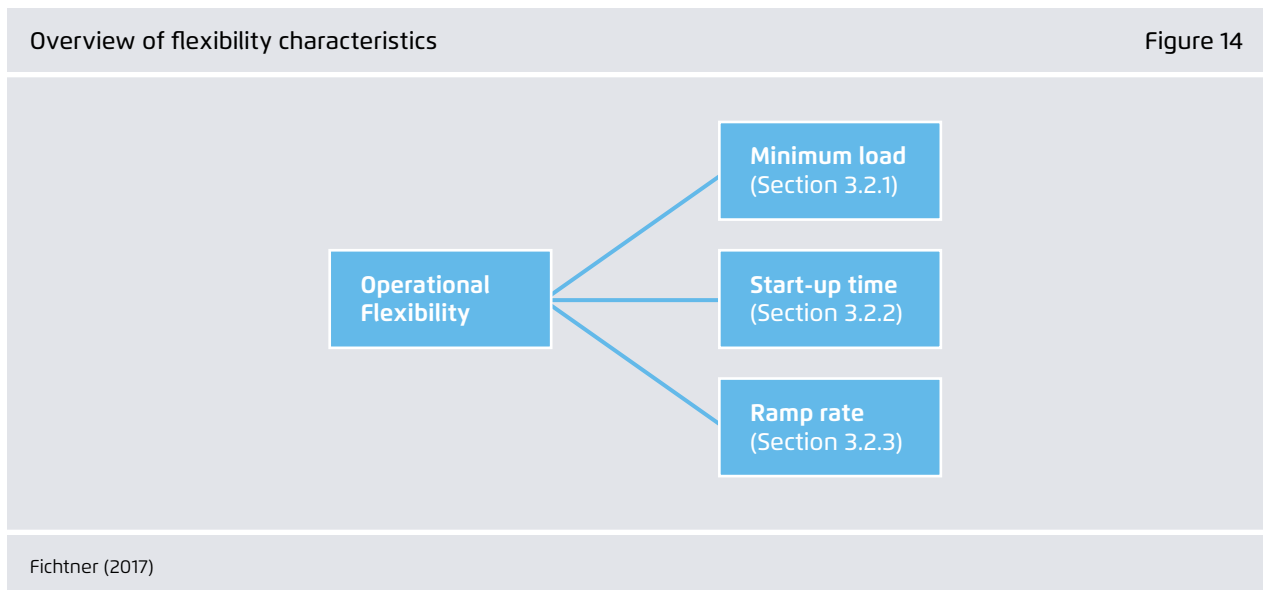

3.2.1 Minimum load

The minimum load, P_{Min} , describes the lowest possible net power a power plant can deliver under stable operating conditions. It is measured in percentage of nominal load, $\% P_{Nom}$. Figure 15 shows a qualitative load curve for a power plant with key power variables.

In this figure, the minimum load is assumed to be 30 % of nominal power P_{Nom} . The net power P_{Net} fed into the grid can range from minimum load to nominal load. The range between minimum and nominal load is called part load operation.

Impact on flexibility

The lower the minimum load, the larger the range of generation capacity. A low minimum load can avoid expensive start-ups and shutdowns.

Disadvantages

At minimum load, the power plant operates at lower efficiency¹².

12 A typical issue with low load operation is also its impacts on the SOx and dust emissions. This dimension is not studied in details in this report. See for example NREL (2014) for more information.

Limitations

The lower the load, the more difficult it is to ensure a stable combustion without supplemental firing¹³

3.2.2 Start-up time

The start-up time is defined as the period from starting plant operation until reaching minimum load. The start-up time of different generation technologies vary greatly. Other factors influencing the start-up time are down time (period when the power plant is out of operation) and cooling rate. Figure 16 illustrates the time for a simplified start-up.

After start-up initiation (t_0), no power is fed into the grid until t_1 . After t_1 , the net power gradually starts to increase. As mentioned above, the start-up time is defined as the period from the start of plant operation (t_0) until minimum load is reached (t_2). Generally, steeper load curve slopes translate into shorter start-up time. The following types of start-ups are defined according by (Gostling, 2002) for power plants:

13 Supplemental firing describes the process of combusting expensive auxiliary fuels, such as heavy oil or gas, in addition to pulverized coal. This stabilizes the flame in the boiler. Such fuels are usually required during the start-up procedure of coal-fired power plants.

Qualitative representation of a power plant load curve with key power variables

Figure 15

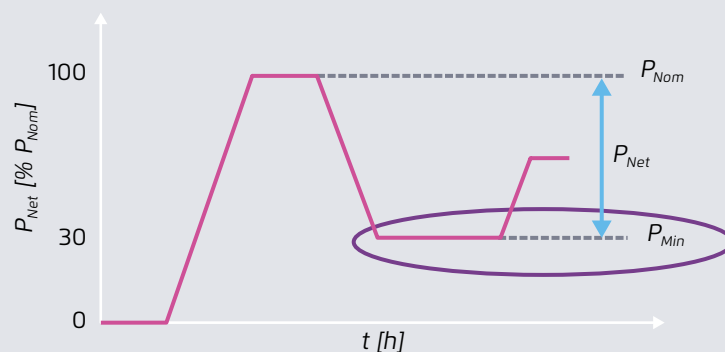

Fichtner (2017)

Net power for a simplified start-up from standstill until nominal operation

Figure 16

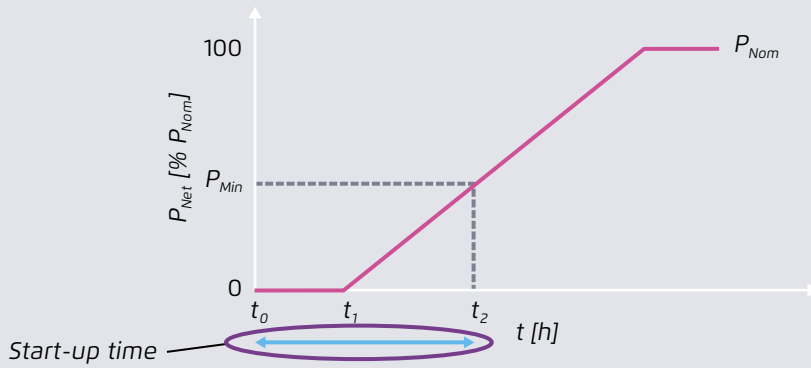

Fichtner (2017)

Hot start-up:

The power plant has been out of operation for less than 8 hours.

Warm start-up:

The power plant has been out of operation for between 8 and 48 hours.

Cold start-up:

The power plant has been out of operation for more than 48 hours.

Generally, a cold start puts a larger strain on plant components than a hot start due to the greater temperature differences that occur during the start-up.

Impact on flexibility

The shorter the start-up time, the quicker a power plant can reach minimum load.

Disadvantages

Faster start-up times put greater thermal stress on plant components, thereby reducing their lifetime.

Limitations

The allowable thermal gradient in Kelvin per minute, K/min, for thick-walled components limits the start-up time speed. The state of development of the automation can also be a limiting factor.¹⁴

3.2.3 Ramp rate

The ramp rate describes how fast a power plant can change its net power during operation. Mathematically, it can be described as a change in net power, ΔP_{Net} , per change in time, Δt .

$$Ramp\ rate = \frac{\Delta P_{Net}}{\Delta t}$$

Normally the ramp rate is specified in MW per minute, MW/min, or in percentage of nominal load per minute, $\% P_{Nom}/min$. In general, ramp rates heavily depend on generation technology, as will be discussed

¹⁴ An increase of temperature causes thermal expansion in metals. During a cold start-up, the temperature changes with time, from initially ambient temperature until reaching nominal operating temperature. Temperature changes spatially as the wall thickness of the components vary. The different states of thermal expansion result in thermal stress. Normally, an allowable thermal gradient with regard to time in Kelvin per minute, K/min, is provided to keep thermal stress below a damaging threshold.

Qualitative depiction of a power plant load curve highlighting the ramp rate

Figure 17

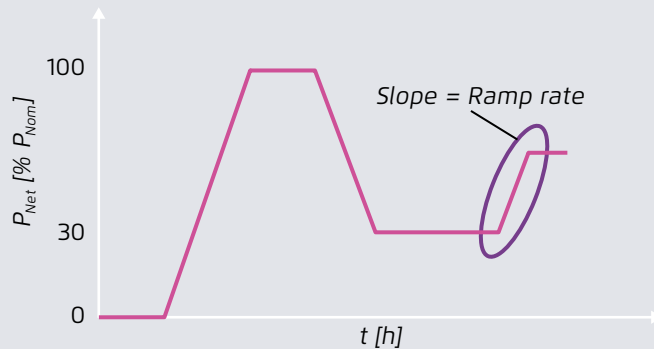

Fichtner (2017)

in Section 3.3. Figure 17 presents a qualitative load curve over time, with the ramp rate visually interpreted as the slope.

Impact on flexibility

A higher ramp rate allows a power plant operator to adjust net power more rapidly to meet changes in power demand.

Disadvantages

A rapid change in firing temperature results in thermal stress for plant components.

Limitations

The allowable thermal stress for thick-walled components and the allowable unsymmetrical deformations limit the ramp rate. For coal-fired power plants, the storage behaviour of the steam generator, the quality of fuel used for combustion (which has a direct effect on temperature variation) and the time lag between coal milling and turbine response can act as limiting factors.

3.2.4 Implications of flexible operation on lifetime and operation and maintenance (O&M) cost of thermal power plants

The following section describes the impact that a more flexible operation has on the lifetime of a thermal power plant and its associated costs.

1. Impact of flexible operation on lifetime

Flexible operation (high ramp rates and multiple starts) has significant influence on the lifetime of a power plant (Ziems, et al., 2012). Thick-walled components are especially affected by thermal stress, which can be derived from ramp rates and start-ups. Load changes of over 50 % of P_{Nom} (from 40 % to 100 % of P_{Nom}) and cold starts put the highest strain on these components.

However, the specific lifetime consumption depends on many parameters (change in temperature, pressure, etc.) and is different for each component.¹⁵ The specific influence of flexible operation and associated

¹⁵ The lifetime consumption is used to capture the effect of power plant operation on the life of components. Critical processes such as starts or load changes of over 50 % P_{Nom} are usually assigned a specific lifetime consumption value as a percentage of the component's life. For example, if a start-up causes a lifetime consumption of 0.005% for a given component, 20,000 starts could be performed before replacement was needed.

lifetime consumption can be calculated using detailed modeling.

Such a modeling was performed for baseline mode and a dynamic operation mode (50 more starts per year and a ramp rate twice as high as the baseline operation mode) for a hard coal-fired power plant in Rostock. The dynamic operation mode increases the accumulated annual lifetime consumption from 0.4% to 3.24% (an increase by a factor of 8). To put this in real terms, the unit would have a theoretical lifetime of 250 years in the baseline scenario and only 31 years in the dynamic operation scenario (Ziems, et al., 2012).

In practice, frequent physical component checks (e.g., X-ray examination, crack testing and micro-structure examination) are necessary to verify component health, as modeling outcomes are "only" theoretical.

In Germany, some power plant operators deliberately push flexibility even though it reduces plant life. In part, this has to do with the shift in energy policy away from coal for the next decades. This explains the higher flexibility of German power plants relative to other countries.

Generally, it is not possible to put lifetime consumption in monetary terms. The reason is that lifetime consumption and the associated loss in revenues largely depend on future earnings, future plant operation, future maintenance, repair strategies, and the like.

2. Impact of flexible operation on O&M costs

Lifetime consumption of thick-walled components is not directly linked to O&M costs. The affected components (headers, etc.) in the HP (high pressure) line are typically designed to be used over the entire lifetime of the plant (typically 40 years). According to NREL (2014), more cycling of fossil-fueled power plants in systems with high shares of variable renewables can increase the cycling costs from

0.5–1.3 \$/MWh in a system without renewables to 1.0–3.0 \$/MWh in a system with 33 percent variable renewables. To put this into perspective this amounts to an increase of approx. 2–5 percent of total variable operation and maintenance cost (27–28 \$/MWh).

From a system perspective, these increased costs are relatively small compared to the fuel savings associated with wind and solar generation.

The lifetime of a plant greatly depends on external factors (electricity price, CO₂, fuel, etc.). If a component needs to be replaced, however, significant costs (>1 million euros) arise.

3.3 Comparison of flexibility parameters in different generation technologies

This section compares the four thermal generation technologies discussed above with regard to flexibility and CO₂ emissions. Once again, these technologies are:

- lignite-fired power plants;
- hard coal-fired power plants;
- open cycle gas turbine (OCGT) power plants; and
- combined cycle gas turbine (CCGT) power plants.

To ensure proper comparison, only larger generation units (300 MW and more) are considered. The state of development also plays a critical role in the comparison:

1. Most commonly used technologies

"Most commonly used technologies" refer to typical, existing plant designs. Generally speaking, today's commonly used technologies are power plants built 10–20 years ago with a state-of-the-art design at the time.

2. State-of-the-art technologies

"State-of-the-art technologies" describe the best technology commercially available when investing in a new power plant project today.

It should be noted that the average values for each generation technology can vary from region to region. A “most commonly used” design in a developed industrial country such as Germany built 10–20 years ago might be more advanced than a comparable power plant in a less developed country.

Section 3.3.1 summarizes the flexibility parameters for each generation technology.

Section 3.3.2 discusses the net efficiencies and specific CO₂ emissions for each technology.

3.3.1 Flexibility parameters

This section presents and compares the flexibility parameters of the four generation technologies. It has three parts:

→ Part 1: General comparison of the four technologies

The first part provides a general comparison of flexibility parameters.

→ Part 2: Detailed comparison between state-of-the-art and most commonly used technologies

The second part provides a more in-depth comparison of most commonly used and state-of-the-art generation technologies with regard to flexibility.

→ Part 3: Comparison of three specific coal-fired power plants

Part three focuses on specific coal-fired power plants in Germany and Poland and compares their flexibility parameters.

Part 1: General comparison of the four technologies

Table 1 provides a summary of the flexibility parameters (minimum load, ramp-rate and start-up time) of most commonly used and state-of-the-art power plants for each generation technology (OCGT, CCGT, hard coal- and lignite-fired power plants). The main finding is that gas-fired power plants (OCGT and CCGT) have a higher operational flexibility relative to coal-fired units. As Figure 18 shows, start-up time is significantly shorter and ramp rates are higher than for hard coal- and lignite-fired power plants.

Ramp rates and start-up times of thermal power plants in comparison

Figure 18

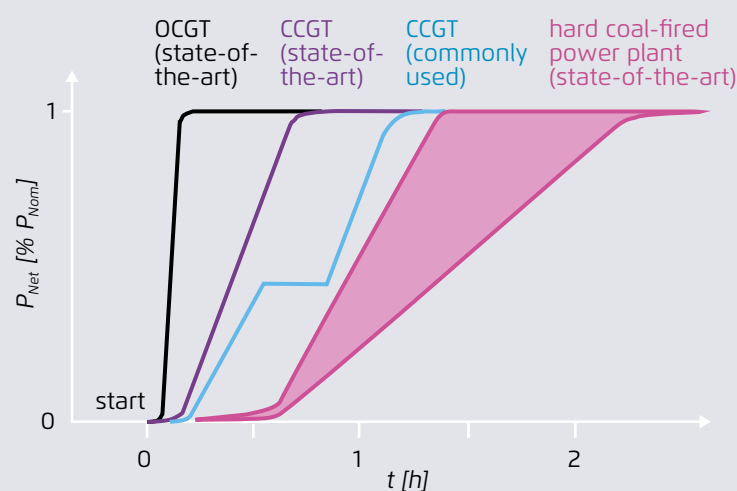

Fichtner (2017) based on (VDE, 2012)

Comparison of most commonly used and state-of-the-art power plants for each generation technology with regard to flexibility

Table 1

Property	OCGT	CCGT	Hard coal-fired power plant	Lignite-fired power plant
Most commonly used power plants				
Minimum load [% P_{Nom}]	40–50%	40–50%	25–40% ^a	50–60%
Average ramp rate [% P_{Nom} per min]	8–12%	2–4%	1.5–4%	1–2%
Hot start-up time [min] or [h]	5–11 min ^b	60–90 min	2.5–3 h	4–6 h
Cold start-up time [min] or [h]	5–11 min ^c	3–4 h	5–10 h	8–10 h
State-of-the-art power plants				
Minimum load [% P_{Nom}]	20–50%	30–40% (20% with SC ^d)	25 ^e –40% ^f	35 ^g –50%
Average ramp rate [% P_{Nom} per min]	10–15%	4–8%	3–6%	2–6 ^h %
Hot start-up time [min] or [h]	5–10 min ⁱ	30–40 min	80 min–2.5 h	1.25 ^j –4 h
Cold start-up time [min] or [h]	5–10 min ⁱ	2–3 h	3–6 h	5 ^k –8 h

- a Source: (Heinzel, Meiser, Stamatelopoulos, & Buck, 2012)
- b Large heavy-duty gas turbines such as the Siemens SGT5-4000F typically have longer start-up times. A fast start takes about 11 minutes and a normal start about 30 minutes.
- c The amount of fuel that can be burned at the maximum continuous rating of the appliance multiplied by the net calorific value of the fuel and expressed as megawatts thermal. The thermal input is specified by the manufacturer of a plant.
- d SC (sequential combustion): Some state-of-the-art CCGT power plants are equipped with sequential combustion, which enables a very low load operation without exceeding emission limits.
- e See (Then, 2016)
- f Minimum load: 25–30% in "recirculation mode" and 35–40% in "once-through mode."
- g See Boxberg "unit R", with a minimum load of 35%.
- h See the "Belchatów II Unit 1" power plant in Poland or the Boxberg power plant in Germany, both with a ramp rate of up to 6% P_{nom} .
- i Large heavy-duty gas turbines such as the Siemens gas turbine SGT5-8000H typically have longer start-up times. A fast start takes about 11 minutes and a normal start about 30 minutes.
- j See the Boxberg power plant "unit R" with a start-up time (hot) of 75–85 minutes.
- k See the Boxberg power plant "unit R" with a start-up time (cold) of 290–330 minutes.

Fichtner (2017); Original sources: (VDE, 2012), (Steck & Mauch, 2008) and (Balling, 2010). The technical data is from OEMs.

Table 1 highlights the following aspects for the most-commonly used power plants:

Minimum load

Hard coal-fired power plants can reach the lowest minimum load with 25 percent of nominal load. Lignite-fired power plants, however, provide the least flexibility, with 50–60 percent of the nominal load.

This is mainly due to combustion stability issues, which are more pronounced in the larger boiler designs present in lignite-fired power plants.

Average ramp rate

In terms of average ramp rates, the OCGT configuration provides the greatest flexibility with 8–12% of nominal power per minute. The OCGT configura-

tion can respond significantly faster than the CCGT configuration due to the thermal inertia of the steam generator and the steam turbine (Cziesla, et al., 2013).

Coal-fired power plants have relatively low ramp rates due to large component dimensions and time lag between an increase in fuel input and turbine response (Cziesla, et al., 2013).

Start-up time

Like the average ramp rate, hot start-up times vary greatly between technologies. Both gas turbine configurations can start significantly faster than coal-fired plants.

For a gas turbine, the start-up time consists of the time required to bring the turbine into a rotary movement, the time to start the ignition, the time to achieve nominal rotational speed and the time to synchronize the generator.

For coal-fired power plants, however, the start-up process is far more complex. It requires the operation of auxiliary systems, such as cooling pumps, fans and burners. Additionally, it takes more time for larger components to reach the required temperature levels to begin operation.

As for state-of-the-art power plants, Table 1 shows that a significant improvement of flexibility can be achieved when compared to most-commonly used technologies :

Minimum load

The minimum load of state-of-the-art power plants can be reduced to 20 percent of nominal load for OCGT and down to 35 percent of nominal load for lignite. This represents a significant improvement relative to most commonly used technologies.

Ramp rate

The ramp rate of most flexible state-of-the-art power plants can be up to 2–3 times higher than the ramp rate of less flexible most commonly used

technologies. The ramp rate of state-of-the-art coal power plants (hard coal as well as lignite) can meet or exceed the ramp rate of most-commonly-used CCGT gas-fired plants.

Start-up time

The start-up time of state-of-the-art technology can be much lower than those of most-commonly used technology, with the exception of OCGTs. In particular, the reduction of start-up time can be as much as several hours for lignite-fired coal power plants. The hot start-up time of new hard-coal power plants are approaching those of most-commonly-used CCGTs.

However it must be pointed out that even for state-of-the-art power plants, coal-fired power plants (hard coal as well as lignite) are still less flexible relative to gas-fired generation units, especially with regard to start-up time and ramp rate.

Part 2: Detailed comparison of state-of-the-art technologies with most commonly used technologies

1) Minimum Load

With most commonly used technologies, hard coal-fired power plants can reach the lowest minimum load with 25–40% of P_{Nom} , as shown in Figure 19. OCGT and CCGT both have a slightly higher minimum load, ranging between 40–50% of P_{Nom} . The most commonly used lignite-fired power plants have the highest minimum load with 50–60% of P_{Nom} .

As Figure 19 shows, most state-of-the-art technologies can achieve significant improvements relative to most commonly used power plants. Technological advancement significantly reduced the minimum load in state-of-the-art OCGT and CCGT power plants. They reach the lowest minimum load with 20–50% and 20–40% (with sequential combustion) of P_{Nom} respectively.

Lignite-fired power plants with state-of-the-art designs have significantly reduced minimum loads,

Comparison of power plants with most commonly used technologies and power plants with state-of-the-art technologies for each generation type with regard to minimum load (values based on Table 1)

Figure 19

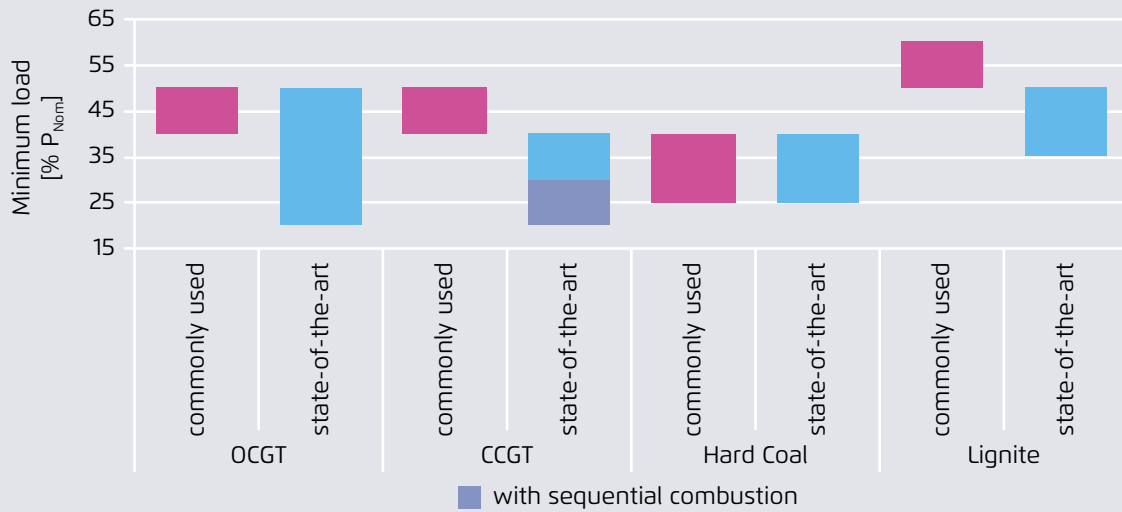

Fichtner (2017)

Comparison of power plants with most commonly used technologies and power plants with state-of-the-art technologies for each generation type with regard to the average ramp rate (values based on Table 1)

Figure 20

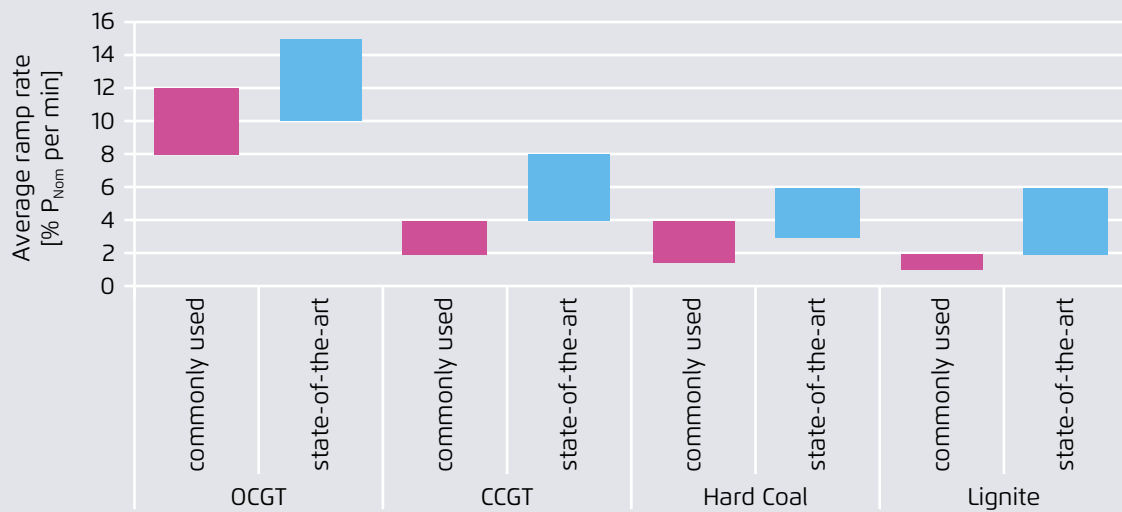

Fichtner (2017)

from 50–60 percent to 35–50 percent. But they still provide the least flexibility with regard to minimum load.

2) Ramp rate

Figure 20 compares the average ramp rate of power plants with most commonly used technologies and power plants with state-of-the-art technologies. As can be seen in this figure, OCGT power plants provide the highest ramp rate, reaching 8–12% of P_{Nom} per minute for most commonly used power plants and 10–15% of P_{Nom} per minute for state-of-the-art power plants.

The ramp rate of CCGT power plants is about two to four times slower than in OCGT power plants. However, the ramp rate of state-of-the-art CCGT (4–8% of P_{Nom} per minute) shows significant improvement relative to the most commonly used CCGT technology (ramp rate of 2–4% of P_{Nom} per minute). Hard coal-fired power plants have similar

ramp rates to CCGT power plants, reaching 1.5–4% of P_{Nom} per minute for hard coal-fired power plants with most commonly used technologies, whereas state-of-the-art power plants improved to 3–6% of P_{Nom} . Of all generation technologies, lignite-fired power plants with most commonly used technologies have the lowest average ramp rates, 1–2% of P_{Nom} per minute. But state-of-the-art lignite-fired power plants can ramp up significantly faster, with an average ramp rate reaching 2–6% P_{Nom} per minute (versus 1–2% for most commonly used technologies).

3a) Start-up time (hot)

Figure 21 illustrates the difference between power plants with most commonly used and state-of-the-art technologies with regard to **hot start-up time**. In both categories, OCGT has by far the shortest hot start-up time among the different generation technologies (5–11 minutes) – followed by CCGT, hard coal-fired power plants and lignite-fired power plants.

Comparison of power plants with most commonly used technologies and power plants with state-of-the-art technologies for each generation type with regard to start-up time (hot <8h) (values based on Table 1)

Figure 21

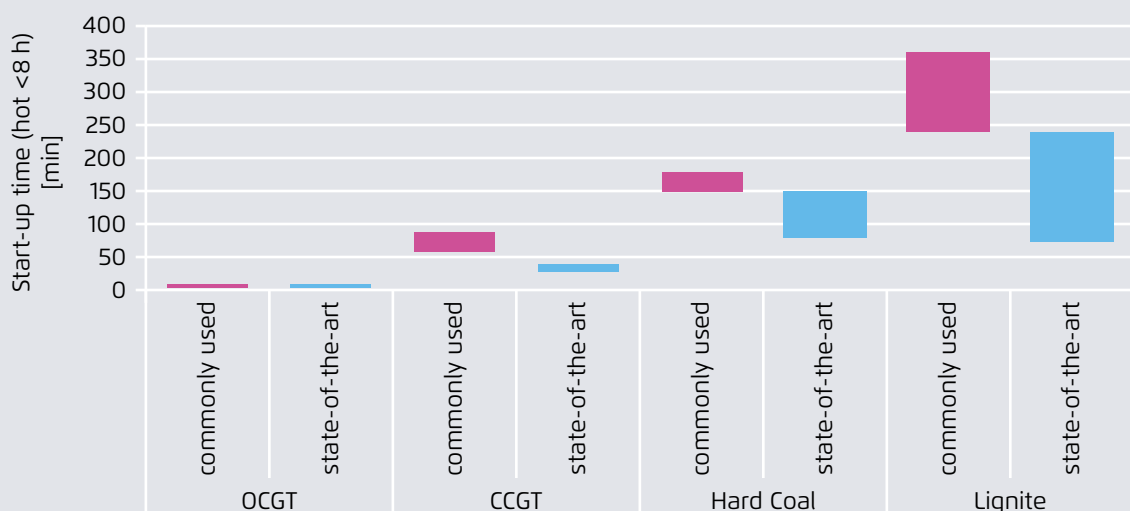

Fichtner (2017)

The range of hot start-up time for OCGT decreases only slightly, from 5–11 minutes (most commonly used) to 5–10 minutes (state-of-the-art). The hot start-up time of CCGT is nearly halved between most commonly used power plants (hot start-up time of 60–90 minutes) and state-of-the-art power plants (hot start-up time of 30–40 minutes).

The hot start-up time for hard coal-fired power plants improved from 150–180 minutes to 80–150 minutes in the state-of-the-art design category. Lignite-fired power plants decreased their hot start-up time considerably, from 240–360 minutes (commonly used) to 75–240 minutes (state-of-the-art).

3b) Start-up time (cold)

Figure 22 compares power plants with most commonly used technologies and with state-of-the-art technologies with regard to **cold start-up time**. OCGT provides the shortest cold start-up time, both

for most commonly used technologies (5–11 minutes) and for state-of-the-art technologies (5–10 minutes), followed by CCGT, hard coal-fired power plants and lignite-fired power plants. The cold start-up time of CCGT improved significantly between most commonly used power plants (180–240 minutes) and state-of-the-art power plants (120–180 minutes).

Most commonly used hard coal-fired and lignite-fired power plants have the longest cold start-up time and therefore the lowest flexibility of all the generation technologies under comparison. The cold start-up time of hard coal-fired power plants range between 300–600 minutes. Lignite-fired power plants lie between 480–600 minutes and thus tend to start slower than hard coal-fired power plants. The cold start-up time of hard coal-fired power plants with state-of-the-art design takes 180–360 minutes less. State-of-the-art lignite-fired power plants have a range of 300–480 minutes.

Comparison of power plants with most commonly used technologies and power plants with state-of-the-art technologies for each generation type with regard to start-up time (cold >48 h) (values based on Table 1)

Figure 22

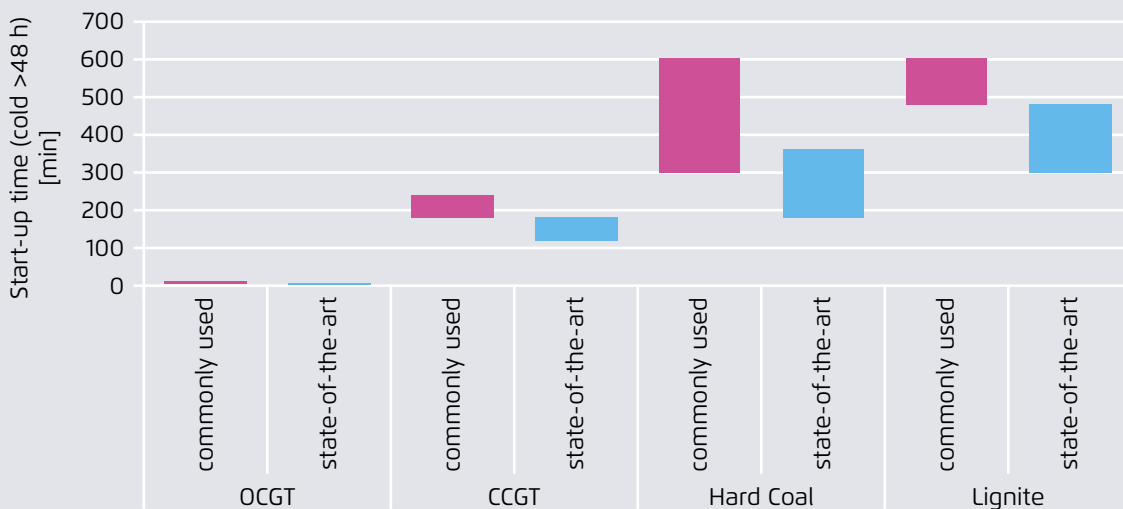

Fichtner (2017)

Part 3: Comparison of three specific coal-fired power plants

This section compares three state-of-the-art coal-fired power plants in terms of flexibility.

Belchatów Power Plant (new unit), Poland

Belchatów power station is Europe's largest power station and is listed as one of the world's largest fossil power stations. With a total installed capacity of 4,400 MW it generates almost 20 percent of the total power output in Poland (SGS Industrial Services, 2011). The new lignite-fired power unit "Belchatów II Unit 1" with 858 MW was completed in 2011. With a minimum load of 45 percent and a ramp rate of 2–6 percent it can be classified as a state-of-the-art lignite-fired power plant. The start-up-times are 140 minutes (hot) and 360 minutes (cold).

Walsum Power Plant, Germany

"Unit 10" of Walsum Power Plant was completed in 2013. This new hard coal-fired unit has an installed capacity of 725 MW (STEAG GmbH, n.d.). The minimum load is 35 percent of nominal load and the ramp rate ranges between 3.5–6 percent. The start-up time (hot) is 66 minutes and thus slightly shorter than the average typical time range given in Table 1 (80 minutes). The start-up time (cold) is about 290 minutes.

Boxberg Power Plant, Germany

Boxberg is a lignite-fired power plant in the eastern part of Germany with a total installed electric capacity of 2,575 MW. The latest unit "unit R", completed in 2012, has an electric capacity of 675 MW. It uses the latest advances in material research and in boiler and turbine technologies (LEAG, n.d.). The minimum load of this new unit is 35 percent of the nominal load and has a ramp rate between 4.6–6 percent. The start-up time under hot and cold conditions range between 75–85 and 290–333 minutes.

Table 2 provides an overview of the coal-fired power plants' flexibility parameters.

Table 2 indicates that these power plants lie in the range of state-of-the-art power plant designs.

3.3.2 CO₂ emissions

This section compares net efficiency and specific CO₂ emissions of thermal generation technologies. Net efficiency indicates power plant operation at nominal load. Average annual net efficiency is lower than net efficiency, since power plants are sometimes operated at part load (when net efficiency decreases).

Comparison of three state-of-the-art coal-fired power plants in Poland and Germany

Table 2

Name	Belchatów (Poland)	Walsum (Germany)	Boxberg (Germany)
Fuel type	Lignite	Hard coal	Lignite
Minimum load [% P_{Nom}]	45% (45–50%)*	35% (25–40%)	35% (45–50%)
Average ramp rate [% P_{Nom} per min]	2–6% (2–6%)	3.5–6% (3–6%)	4.6–6% (2–6%)
Hot start-up time [min] or [h]	140 min (1.25–4 h)	66 min (80 min–2.5 h)	75–85 min (1.25–4 h)
Cold start-up time [min] or [h]	360 min (5–8 h)	290 min (3–6 h)	290–330 min (5–8 h)

* The values in italics represent the average values for state-of-the-art power plants and are based on Table 1 Fichtner (2017)

Net efficiency and specific CO₂ emissions for the most commonly used generation technologies at nominal operation

Table 3

Property	OCGT	CCGT	Hard coal-fired power plant	Lignite-fired power plant
Net efficiency [%]	39.5%	up to 59%	43%	42.5%
Fuel specific CO ₂ emissions [g CO ₂ /kWh _{th}]	202–300	202–300	325–350	340–410
CO ₂ emissions of electricity generation [g CO ₂ /kWh _{el}]	511–759	342–508	756–814	800–965

Fichtner (2017), Prognos (2016), INAS (2014)

CO₂ emissions for each technology are determined by the specific net efficiency and specific fuel emissions. The overall life cycle CO₂ emissions for each fuel depend on the carbon intensity of each energy source and on the technologies used for exploration and transportation.

Table 3 summarizes the values for the most commonly used generation technologies.

Table 3 shows that CCGT have higher net efficiency, with values of up to 59 percent. Both lignite- and

hard coal-fired power plants are very similar with regard to net efficiency but show considerable difference in specific CO₂ emissions. This mostly has to do with the high specific CO₂ emissions of lignite.

Table 4 summarizes the values for state-of-the-art generation technologies.

State-of-the-art CCGT configurations have the highest efficiency of all the generation technologies under consideration. Hard coal-fired power plants achieved the greatest improvement between the two develop-

Net efficiency and specific CO₂ emissions for state-of-the-art generation technologies at nominal operation

Table 4

Property	OCGT	CCGT	Hard coal-fired power plant	Lignite-fired power plant
Net efficiency [%]	39.7%	60%	46%	43%
Fuel specific CO ₂ emissions [g CO ₂ /kWh _{th}]	202–300	202–300	325–350	340–410
CO ₂ emissions of electricity generation [g CO ₂ /kWh _{el}]	509–756	337–500	707–761	791–953

Fichtner (2017), Prognos (2016), INAS (2014)

ment stages, increasing net efficiency by 3 percent. The net efficiency of OCGT increased only marginally, by 0.3 percent, from the most commonly used technologies to state-of-the-art designs.

The low specific CO₂ emissions from OCGT are on account of its high efficiency and the fuel characteristics of natural gas. Once again, lignite causes the highest specific CO₂ emissions.

The impact of flexible operation on efficiency and CO₂ emissions of power plants is discussed in more details in Sections 4.2 and section 5.2.

4. Retrofits to increase flexibility of coal-fired power plants – Options, potential and limitations

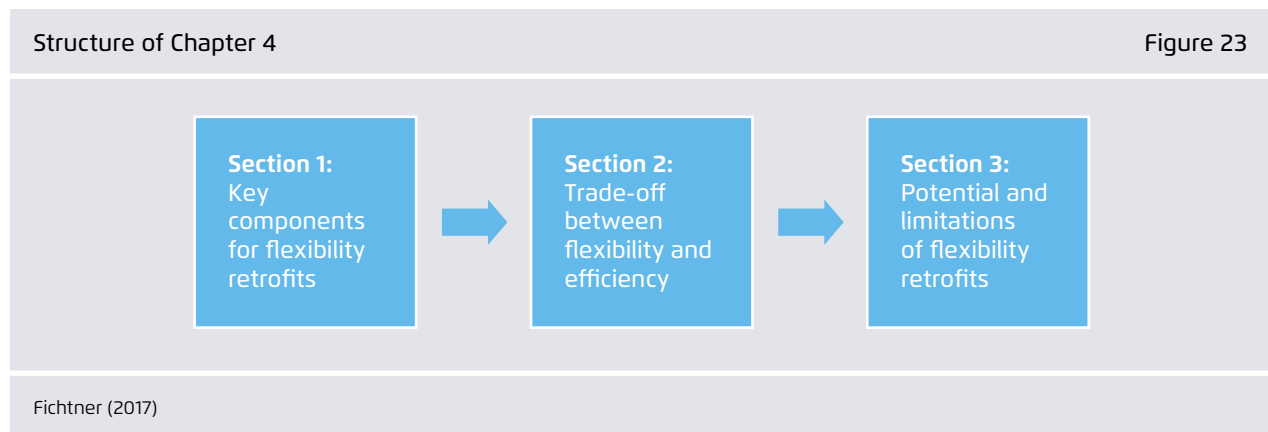

This chapter explores retrofits on key power plant components to improve flexibility. (Whenever possible, available options are presented and supported by quantitative data.) It also discusses the trade-offs between flexibility and efficiency and elaborates on the potential and limitations of flexibility retrofits.

The structure of this chapter is presented in Figure 23.

But first a general definition:

Retrofit

In the field of power plant technology, a retrofit is defined as a modernization or upgrade of power plant components or subsystems. In general, a retrofit is performed as part of a major overhaul and usually requires a power plant standstill lasting multiple weeks.

Retrofits are performed for various reasons, such as improving plant efficiency, increasing flexibility or extending the lifetime of components. This chapter focuses solely on retrofits aiming to increase operational flexibility.

4.1 Key components for flexibility retrofits

To gain a better understanding of coal-fired power plant operation, it is helpful to look at its subsystems. Figure 24 shows a schematic view of a coal-fired power plant divided into 20 subsystems. Each subsystem fulfils a crucial role in the power plant.

Research has shown that retrofits on the following subsystems are the most effective means for increasing plant flexibility:

3 – Control and communication system

This subsystem is the “operating system” of the power plant and comprises all components for control and communication between subsystems. Among other things, it enables the control of the temperature and pressure inside the boiler.

5 – Oil and fuel supply for ignition

To initiate coal combustion, the air volume in the interior of the boiler needs to be brought to a certain temperature and pressure. This is typically done by burning auxiliary fuels, such as oil or gas. This

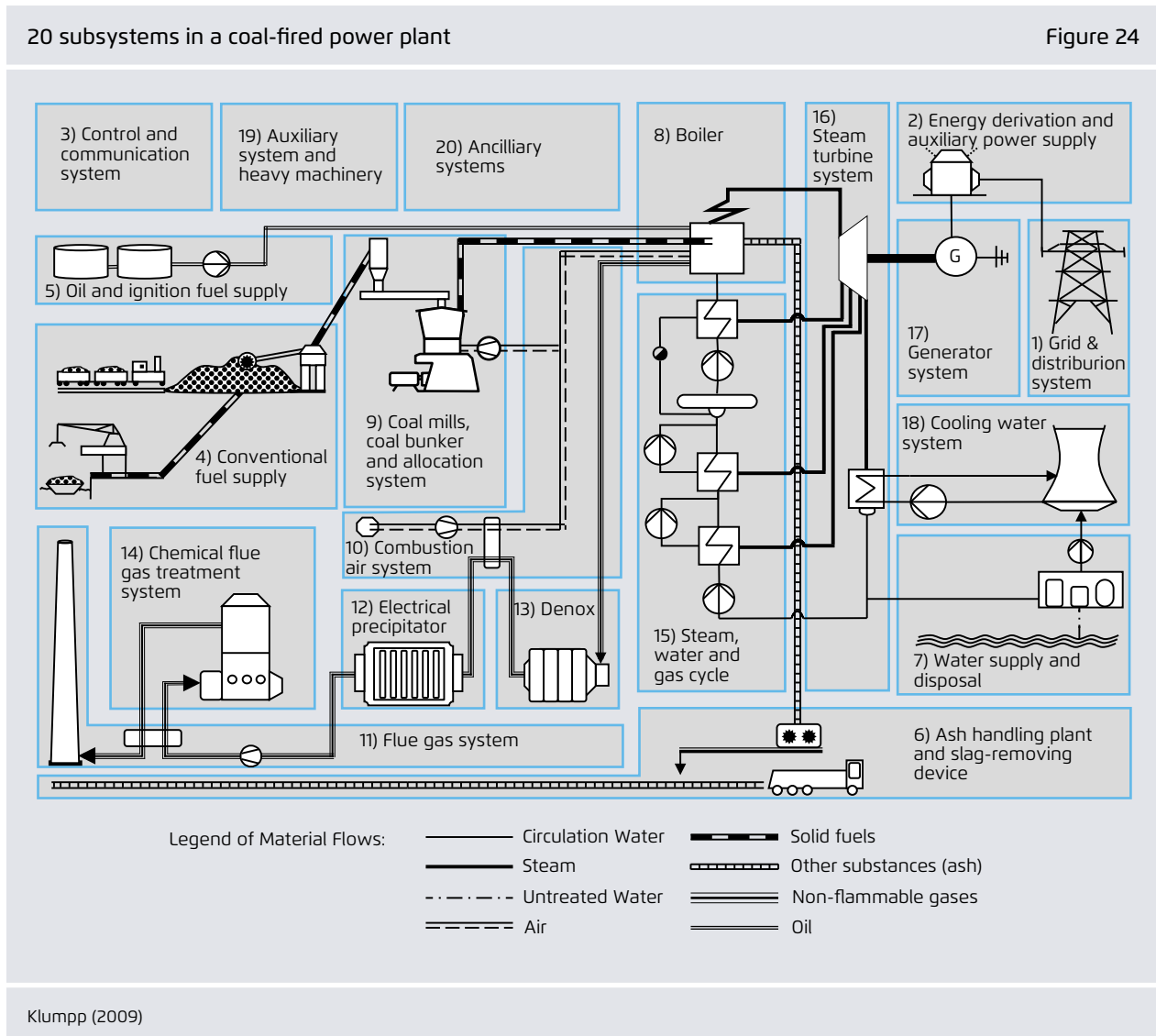

subsystem plays a crucial role during the start-up of coal-fired power plants.

8 – Boiler

The main task of the boiler is to turn feed water into steam. Therefore, it is also referred to as the steam generator. Today, steam is typically generated in a single-pass, once-through boiler often in tower construction design (see Figure 25). The radiative heating surface (the inner boiler surface, shown red in Figure 25) have pipes mounted inside, where the water evaporates. The convection tube banks, where the steam is overheated, are mounted vertically above the burner-stages. Steam temperatures are limited to 560/600 °C, allowing conventional ferritic tube materials to be used.

Schematic illustration of a boiler in a tower construction

Figure 25

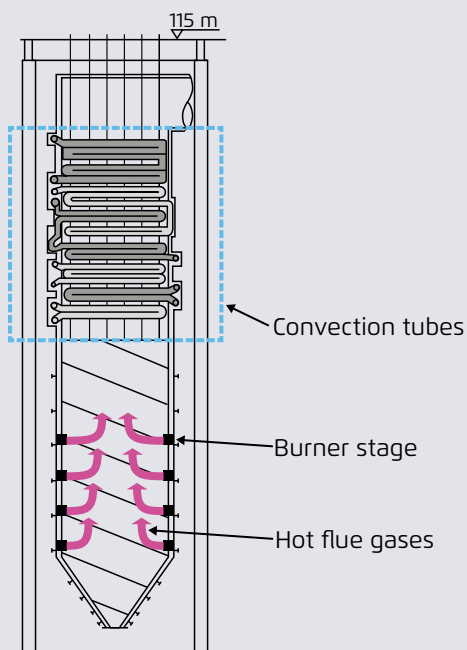

Fichtner (2017) based on Strauss (2016) & Scheffknecht (2005)

There are two main methods to remove the ash produced by coal combustion: **slag tap** and **dry ash removal**.

With dry ash removal, combustion takes place in a furnace with small dimensions and little cooling. In slag-tap furnaces, the temperature is higher than the melting temperature of the ash. This produces molten ash, which is diverted and then released as fusion granulate.

In the case of dry ash removal, ash is discharged via the bottom hopper and by means of an electrostatic precipitator. The ash is swept out with the flue gas, where it remains in a dry, solid state.

Due to their high combustion temperatures, slag-tap furnaces produce high emissions of thermal NO_x , which despite combustion modification measures can barely be kept below the emission limits defined by federal environmental regulations¹⁶. The more ambitious the limits, the tighter the constraints on firing temperature.

The advantage of the slag-tap firing system is that the ash can be recovered completely as marketable slag, a common industrial building material.

The burners are operated using pulverized coal from the coal mills (subsystem 9 in Figure 24). The advantage of pulverized coal is that it burns similarly to gas (Strauss, 2016). This technology can be used for most types of coal. The pulverized coal is transported via an air stream from the coal mills to the burner. In the burner, the coal is combusted together with air from the coal mill (primary air) and additional air for combustion (secondary air).

There are two types of burner constructions: **jet burners** and **vortex burners**. Jet burners are most commonly used in a tangential firing config-

¹⁶ see (NREL 2014) for more information on the impact of cycling on NO_x emissions.

Tangential firing burner configuration with 4 burners on one stage

Figure 26

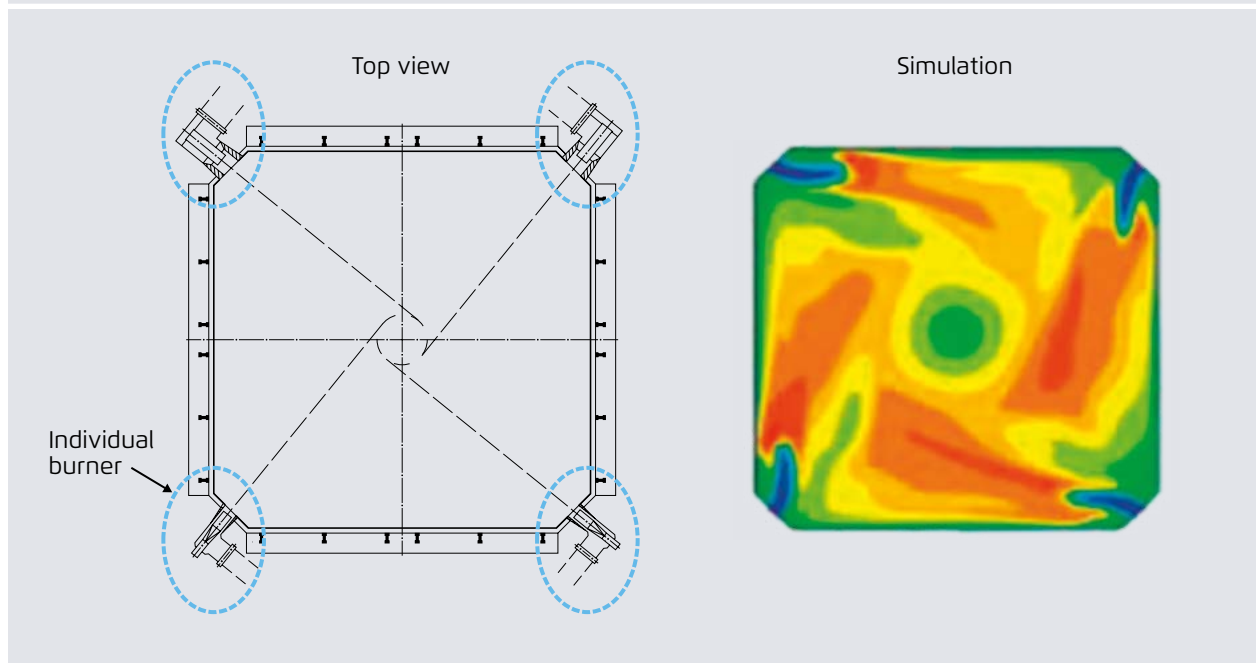

Strauss (2016) & Heinzl, et al. (2012)

uration (Figure 26). The primary and secondary air stream mix due to the velocity difference of the two jets.

The colors in the simulation in the figure above represent temperature. The highest temperatures (red and orange) are achieved in the air stream where the pulverized coal combusts.

Vortex burners feed in the air concentrically. The mixture of both air streams is influenced by their velocity difference. Unlike jet burners, a vortex burner can be installed as a single burner in the boiler, which permits a more unconstrained design (Strauss, 2016).

9 – Coal mills, coal bunker and allocation system

In this subsystem, the raw coal is milled into pulverized coal (PC).

For **lignite-fired** power plants, the coal is milled via beater-wheel mills and dried with hot flue gas (up to 1,000 °C).

For **hard coal-fired** power plants, the vertical roller or bowl mill is used to produce pulverized coal. Since the water content of hard coal (2–7%) is significantly lower than lignite (45–60%), the drying process is much less energy intensive. A hot air stream is sufficient enough to drive out remaining water. After the milling process, coal dust is blown into the boiler.

In general, tube mills are more flexible than beater-wheel mills. Tube mills use a rotating cylinder to pulverize the coal. Bowl mills are considered the most inert of the three types (Scheffknecht, 2005).

15 – Steam, water and gas cycle

This subsystem is closely linked with the boiler and the steam turbine. Its functions include the pre-heating of the feed water.

Before the feed water enters the boiler it is pre-heated by different heat exchangers. Usually, this is done by extracting hot steam from the steam turbine and cooling it in the heat exchangers. The tempera-

ture of the feed water increases as it flows through the exchangers. Pre-heating the feed water is an important process in optimizing power plant efficiency.

16 - Steam turbine

The steam turbine converts pressure and thermal energy into mechanical—i.e. rotational—energy and is situated in the machinery hall. Unlike gas turbines, which rotate in a hot flue gas flow, steam turbines rotate in vaporized water.

In large power plants, steam turbine systems contain high-pressure, intermediate-pressure and low-pressure sections. The steam turbine is mounted on a common shaft connected to the generator (subsystem 17 in Figure 24), which transforms mechanical energy into electrical energy.

Options for improving operational flexibility are presented below.

4.1.1 Options for decreasing minimum load

Before proceeding, it is useful to recall why a decreased minimum load benefits power plant operation.

Reasons for decreasing minimum load

Decreasing minimum load is beneficial because it provides a larger range of generation capacity. This helps plant operators maintain operation when power demand is low and avoid expensive start-up and shutdown procedures. From a system standpoint, reducing the minimum load of conventional power plants allows a greater share of renewables by avoiding potential curtailment.

Reducing the minimum load in hard coal-fired power plants is subject to certain technical limitations. According to (Heinzel, et al., 2012) these limitations are fire stability (see explanation below), flame control, ignition, unburned coal and CO emissions.

Fire instability can occur for different reasons, such as sudden changes in firing rate or fuel quality, improper fuel-air ratios or uneven flows of pulverized coal (Sarkar, 2015). In low load operations, fire can become unstable when the hot flue gases do not completely ignite the inflowing pulverized coal.

Under those constraints, the minimum load of hard-coal power plants with dry ash removal is typically 25–40% of P_{Nom} . For slag-tap firing systems, the minimum load is around 40% because the temperature required to maintain the flow of liquid ash is higher. For lignite-fired power plants, it is between 40–50% because lignite must be dried during milling.

Several retrofit options exist for overcoming many of these technical limitations:

Option 1: Indirect firing

Indirect firing (IF) involves the use of a pulverized coal (PC) storage facility, a so-called dust bunker, situated between coal mills and burners. This decouples the direct supply chain between mills and burners (Figure 27).

Decoupling has the following effects:

- stable fire at low load because of faster response to fire instabilities;
- reduced net power feed-in because coal mill operation is held at nominal levels during low loads; and
- higher ramp rate during operation thanks to reduced time lag between mills and burners.

Effects a and b help decrease the minimum load that is fed into the grid. Effect c will be discussed in Section 4.1.3.

With **direct firing (DF)**, mills must reduce their load during low load power plant operation (at night, say). With indirect firing, mills can run at nominal load even if the pulverized coal is not immediately required because it can be stored in the dust bunker. This allows the auxiliary power needed for milling to

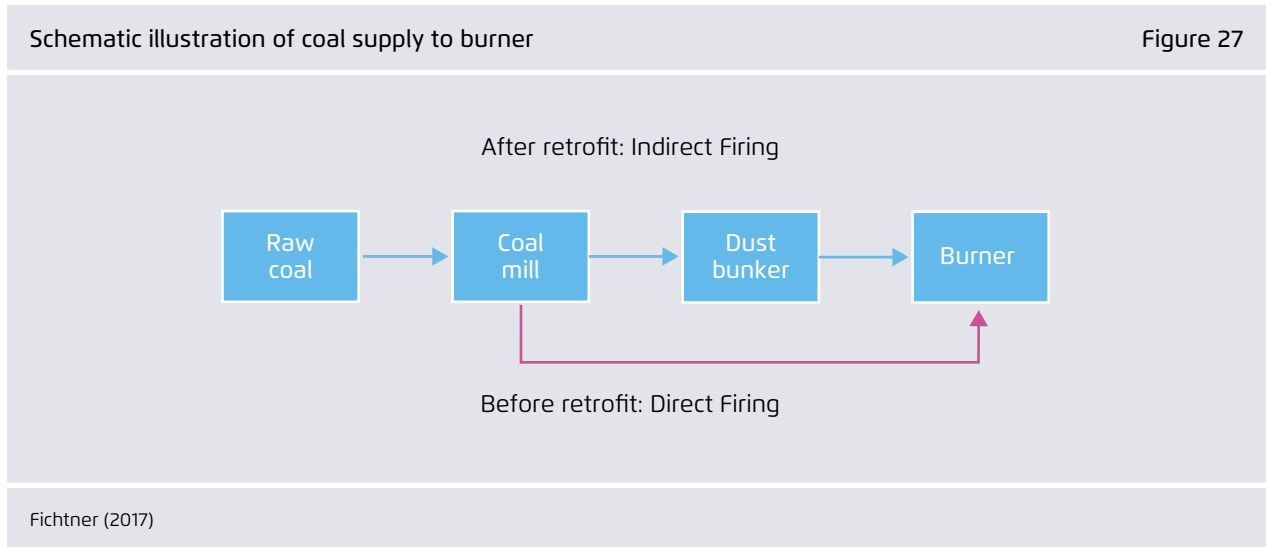

ramp up when the load is low (at night, say). By maintaining nominal mill operation when load is low, this reduces the net power fed into the grid, as illustrated in Figure 28.

The figure shows the qualitative reduction in minimum load fed into the grid P_{Min} for indirect and direct firing configurations. The difference between $P_{Min,IF}$ and $P_{Min,DF}$ results from the difference in milling power ΔP_{Mills} .

Direct firing requires coal mills to operate under part load during periods of low power plant load. The resulting drop in efficiency leads to an increase in specific CO_2 emissions. In indirect firing, coal mills maintain nominal load and can run at optimal efficiency. This translates into a reduction of specific CO_2 emissions.

According to (Jeschke, et al., 2012), implementing indirect firing in combination with a staged vortex burner retrofit can decrease the minimum stable

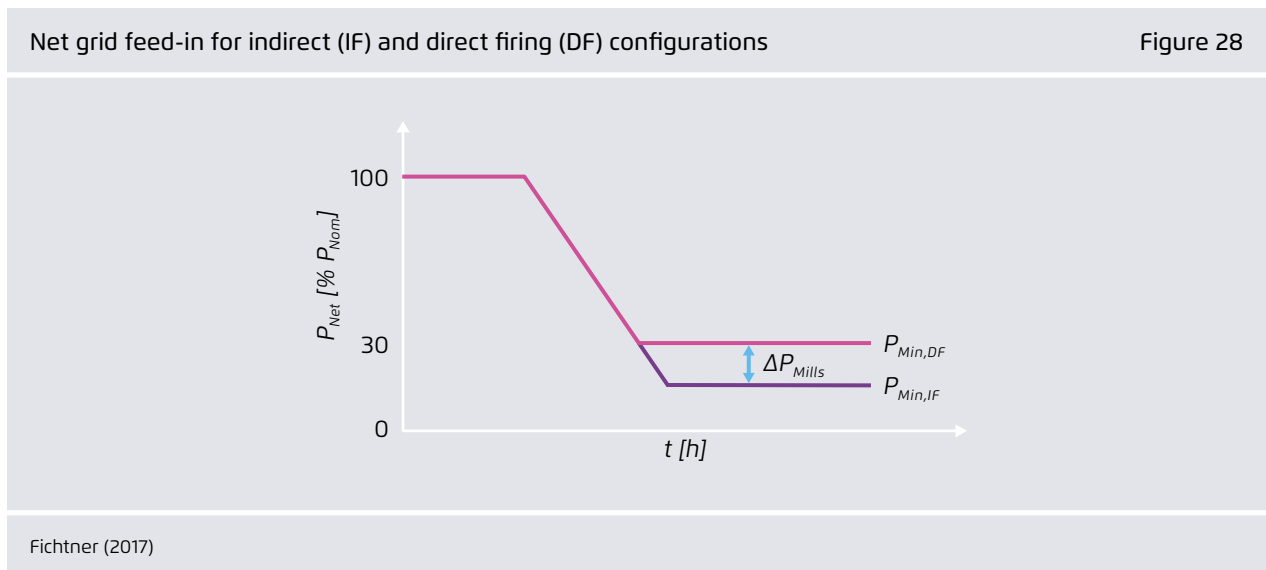

firing rate from 25–30 % to 10 %. Indirect firing is also applicable to other burners, such as jet burners. In general, firing rate and net power are proportional. A reduction of the firing rate therefore leads to a similar reduction of minimum load. Another advantage of reaching a low stable fire is that the need for ignition fuels, such as oil or gas, can be reduced by 95 %.

Option 2: Switching from two-mill to single-mill operation

Coal mills grind lignite or hard coal to pulverized coal (PC). The PC is transported via air stream (primary air) to the burners, where it is then combusted

inside the boiler (Figure 29). In the direct firing configuration, reducing the net power of a power plant requires the burners and the coal mills to both run at part load. At a certain firing rate, the fire becomes unstable, requiring the power plant controller to limit the low load operation in order to avoid damaging pressure pulses that can occur inside the boiler. The fire stability typically represents the lowest threshold for low load operation.

At a certain net power output, it is feasible to shut down some of the mills (typically 4 to 6 in number) and have the remaining mills operate closer to their

Coal mill and burner arrangement of a boiler in tangential firing configuration with four burner stages (single-mill operation)

Figure 29

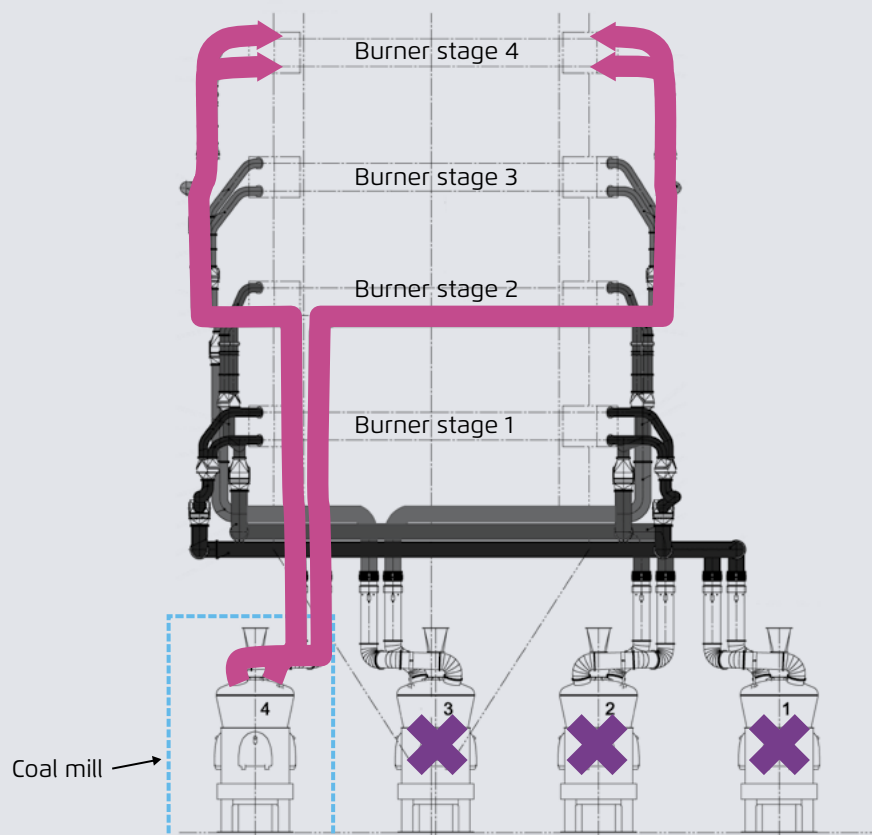

Fichtner (2017) based on Heinzl, et al. (2012)

design point. Since coal mills typically supply a single burner stage with PC, turning off a mill leads to a boiler operation with a reduced number of burning stages.

Figure 29 shows a technical drawing of a mill/burner arrangement in a boiler of a hard coal-fired power plant (Heinzel, et al., 2012). The purple crosses mark mills that are turned off. The pink arrows illustrate the flow of air conveying the pulverized coal from mill 4 to the burner stage 4, where it is blown into the interior of the boiler (combustion chamber).

In single-mill operation, only the highest burner stage is operated for the benefits of releasing heat "higher" in the boiler (Figure 30).¹⁷

¹⁷ According to (Heinzel, et al., 2012), operating the highest burner stage in combination with a large air excess compensates for lower steam and flue gas temperatures by creating a colder flame and more flue gas.

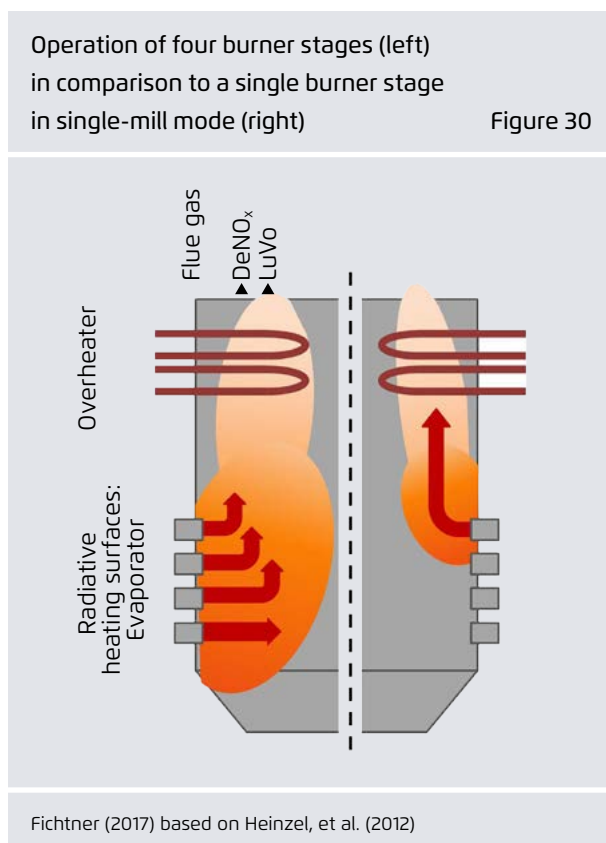

Relative to two-mill operation, single-mill operation can significantly reduce the minimum load while increasing operational stability. The limitations for minimum load operation are shifted from the boiler side (mainly flame stability) to other sections of the power plant, such as the water-steam circuit.¹⁸

Experiments at Heilbronn Unit 7 and Bexbach, both hard coal-fired power plants in Germany (start of operation in 1985 and 1983, respectively) (Heinzel, et al., 2012) have shown that a reduction of minimum load to 12.5% P_{Nom} was possible by switching from a two- to a single-mill operation. In fact, it was found that single-mill operation achieved greater fire stability than two-mill operation since both the burner stage and the mill can operate closer to their design point. Since the end of 2011, single-mill operation is being used commercially in both power plants.

At **Bexbach** (721 MW P_{Nom}) the minimum load was reduced from 170 MW (two-mill operation) to 90 MW in single-mill operation (12.5% P_{Nom}). It was found that the process variables were more stable in single-mill than in two-mill operation. For proper monitoring of burner stage 4 in single-mill operation, additional flame controllers had to be installed. No auxiliary firing is required for stable operation at 90 MW net power. However, to increase the load from 90 MW (ramp up), auxiliary firing with oil is necessary (Heinzel, et al., 2012).

At **Heilbronn Unit 7** (800 MW P_{Nom}) single-mill operation achieved a reduction of the minimum load from 200 MW (two-mill operation) to 100 MW (12.5% P_{Nom}). The fire was found to be more stable than in two-mill operation. Two additional flame controllers were installed on each burner stage to achieve improved flame monitoring. A substantial task for implementing single-mill operation was the

¹⁸ On the boiler side, the lower load requires switching from variable pressure to minimum pressure operation. To maintain appropriate pressure levels in the water-steam circuit, steam flow at the mid-pressure turbine inlet can be held back. DeNOX (flue gas denitrification) operation remained unproblematic.

adjustment of control technology and boiler safety (Heinzel, et al., 2012).

Option 3: Upgrade of control system in combination with plant engineering upgrades

Control technology plays a crucial part in power plant operation. It allows navigation between different loads and ensures stable operation by adjusting all relevant process variables. In the context of coal-fired power plants, the control system monitors and controls the temperature and pressure inside the boiler, the feed-water mass flow in the water-steam circuit, the load point of the coal mills and the turbine valve positions.

An upgrade of the control system improves precision, reliability and speed of control. For instance, it allows operation closer to the material limitations of important components, such as the boiler. This can mean operation at very high temperatures without significantly reducing material lifespan. An upgrade of the control system is usually combined with plant engineering upgrades, such as retrofits of the boiler or the turbine or other components.

Example 1:

Weisweiler lignite-fired power plant, Germany

Unit G and H at Weisweiler, each with 600 MW, P_{Nom} , received a digital control system and other plant engineering retrofits.

According to (Frohne, 2012) & (RWE Power AG, 2012), the retrofit at Unit G decreased minimum load by 170 MW and resulted in an increase of ramp rate. (For more, see Section 4.1.3.) The total cost of the retrofit was 60 million euros. The retrofit at Unit H reduced the minimum load from 400 MW to 290 MW. The total cost amounted to 65 million euros (RWE Power AG, 2011).

Figure 31 shows the difference from before and after the retrofit in terms of nominal power, minimum power and ramp rate of Units G and H at Weisweiler.

The minimum power is significantly lower pre-retrofit, while the ramp rate (slope of the curve) increases.

Example 2:

Lignite-fired power plant Neurath, Germany

According to (Schulze & Hoffmann, 2013), an upgrade to the control system and plant engineering components including the boiler, condenser and the cool-

Load curves for pre-retrofit and post-retrofit of Unit G and H at Weisweiler

Figure 31

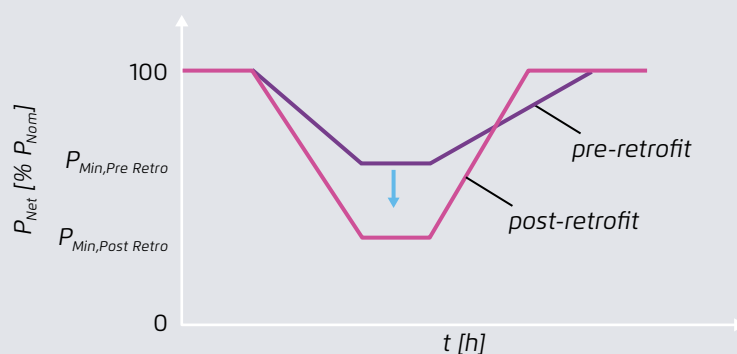

Fichtner (2017) based on Frohne (2012)

ing tower at **Unit E** (600 MW P_{Nom}) of the Neurath lignite-fired power plant decreased the minimum load from 440 to 290 MW. Additionally, efficiency improved by 0.6 % and the ramp rate increased. (See Section 4.1.3.) The total cost of this retrofit amounted to 70 million euros (RWE Power AG, 2011).

Based on (Schulze & Hoffmann, 2013), a retrofit of the control system and plant engineering at Neurath **Unit D** (600 MW P_{Nom}) decreased minimum power from 440 MW to 260 MW and increased the ramp rate. (See Section 4.1.3.) In addition, the retrofit allowed positive and negative control power to be delivered to the market. Previously, only negative primary control power could be achieved (by throttling the turbine inlet valve). Now, condensate stop operation enables positive primary control power as well. Unit D also gained prequalification for 75 MW of secondary control power.

Option 4: Auxiliary firing with dried lignite ignition burner

Auxiliary firing describes the process of stabilizing the fire in the boiler by combusting auxiliary fuels, such as heavy oil or gas, in addition to the PC-fired main burners. This allows for an overall lowering of the stable firing rate in the boiler. Auxiliary firing can also be used for rapid increases to the firing rate, which have a positive influence on the ramp rate. (See Section 4.1.3.)

Since fire stability in the boiler usually limits the minimum load, auxiliary firing can support the minimum load reduction.

As part of a research project at the Jänschwalde lignite-fired power plant, the ignition burners (combusting heavy oil and gas) were replaced with a type that runs on dried lignite. The finely milled dried lignite is carried through the burner by an air stream. Plasma (induced by microwaves) ignites the lignite at the lance near the burner exit. The goal of the project was to use the ignition burner also for auxiliary firing.

According to (Michels, 2016), operating the dried lignite ignition burner for auxiliary firing reduced the minimum load from 36 % to 26 % P_{Nom} .

Another advantage of operating the burner with dried lignite is that it reduces the need for high quality and expensive fuels, such as heavy oil or gas. According to (FDBR, 2012) auxiliary firing can additionally improve the overall efficiency of the power plant.

Option 5: Thermal energy storage for feed water pre-heating

Thermal energy storage can be used to store heat and release it at a later point in time. It presents an interesting concept for influencing net power without changing the firing rate in the boiler (subsystem 15 in Figure 24).

In a typical configuration, the feed water is pre-heated in a heat exchanger with steam extracted from the steam turbine. This increases the overall efficiency of the power plant and offsets the loss of turbine power caused by the steam extraction.

Releasing or absorbing heat to or from the feed water has, therefore, a direct influence on net power because it influences the amount of steam extracted from the turbine.

The operation of a storage system consists of **charging** and **discharging** cycles.

Charging is done by transferring heat from the feed water to the storage system. To maintain a constant feed water temperature, more steam must be extracted from the steam turbine, leading to a reduction in net power. Crucial for reducing the minimum load is that charging take place during periods when loads are low (at night, say).

Figure 32 shows how charging a thermal energy storage (TES) system can reduce minimum power.

Charging a thermal energy storage system and its influence on net power fed into the grid

Figure 32

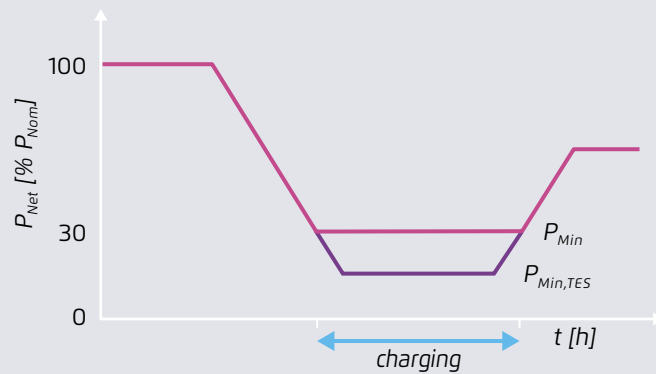

Fichtner (2017)

The minimum load achieved during the charging process is lower than in the normal configuration. It is important to note that the reduction of net power has no influence on the firing rate in the boiler.

According to (Schmidt & Schuele, 2013), the use of a hot water storage system that can operate for 2–8 hours can reduce the minimum power fed into the grid by 5–10 percent (Schmidt & Schuele, 2013). Discharging the stored thermal energy can temporarily increase net power by 5 percent without increasing the firing rate.

Smaller hot water tanks (operation for less than 30 minutes) can be used to improve the ramp rate (Schmidt & Schuele, 2013). Section 4.1.3 will discuss options for improving the ramp rate in more detail.

4.1.2 Options for decreasing start-up time

Before presenting retrofit options, let's first recall why a decreased start-up time benefits power plant operators.

Reasons to decrease start-up time

Power plant operators want to decrease start-up time because it enables a more rapid response to power demand. Start-up procedures are complex and expensive since they usually require auxiliary fuel, such as oil or gas, during the ignition period.

There are various technical factors that limit the reduction of start-up time. Thick-walled components allow higher operating parameters (steam temperature and pressure, say), which increase efficiency. But quick temperature changes in thick-walled components induce thermal stress, which acts as a limiting factor for the start-up time. With "thinner" component designs, flexibility can be higher but efficiency is usually lower.

Several options exist for shortening start-up time in power plants that have not been built with flexibility in mind. Four of these retrofit options are described in the following section: repowering, predictive boiler operation, advanced turbine design and enhanced turbine start-up.

Simplified illustration of a coal-fired power plant with a gas turbine employed for feed water pre-heating

Figure 33

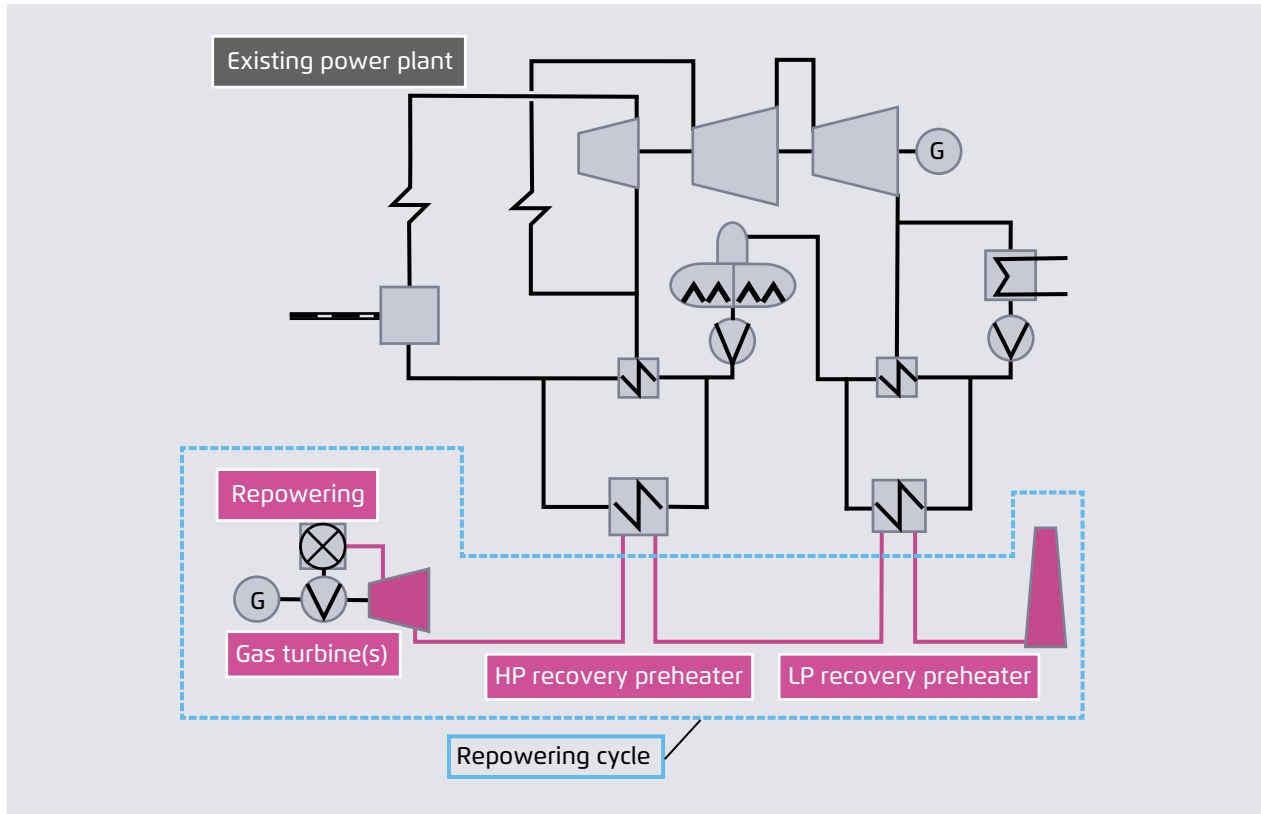

The black lines connecting the grey components represent the water-steam circuit. Fichtner (2017) based on Jeschke, et al. (2012).

Option 1: Repowering

Repowering involves placing a gas turbine upstream of the water-steam circuit in coal-fired power plants. The thermal energy in the exhaust stream of the gas turbine is then transferred to the feed water via heat exchangers (see Figure 33).

Gas turbines can ramp up significantly faster than coal-fired power plants. For hot starts, state-of-the-art OCGT designs require about 5–10 minutes, whereas hard coal-fired power plants take from 80 minutes to 2.5 hours. According to (Jeschke, et al., 2012), repowering increases the gross output of the power plant, improves total efficiency and start-up performance and increases ramp rate. (For more, see Section 4.1.3.)

An increase in gas turbine power output directly increases the heat transfer to the feed water of the water-steam circuit. This reduces the steam extraction needed from the steam turbine, which translates into higher steam turbine output. (See Section 4.1.1, Option 5.)

In terms of start-up performance, repowering is especially helpful because the gas turbine can provide power while the water-steam circuit is still heating up. In 2006 and 2007, two gas turbines with 190 MW of net power each were installed in Units G and H at Weisweiler. Pre-heating the feed water with gas turbine exhaust increased the net power (of the coal-fired unit) by 80 MW (+ 6.6% P_{Nom}), because less steam had to be extracted from the steam turbine.

The total investment amounted to 150 million euros (RWE Power AG, n.d.).

In **sum**, repowering

- increases the net power of the coal-fired power plant;
- improves flexibility; and
- increases efficiency, which leads to lower specific CO₂ emissions.

Option 2: Optimized control systems

Predictive controller solutions such as ABB's *BoilerMax* are used for the online optimization of start-ups. Such control systems use dynamic optimization, which beat the performance of conventional control systems. *BoilerMax* optimises several parameters to shorten boiler start-up time (Figure 34).

The parameters include among others fuel costs and thermal stress on thick-walled components (Franke & Weidmann, 2008).

BoilerMax has been installed in several E.ON power plants in Germany, including the 450 MW coal-fired unit Zolling 5. The start-up time is shortened by 33 percent, as can be seen in Figure 35.

Once installed in the control system, *BoilerMax* allows plant operators to shorten plant start-up time. A shorter start-up time normally implies higher thermal stress for the materials. The tool also provides plant operators with the opportunity to choose between different start-up options, allowing them to adjust the specific start-up to the current market situation.

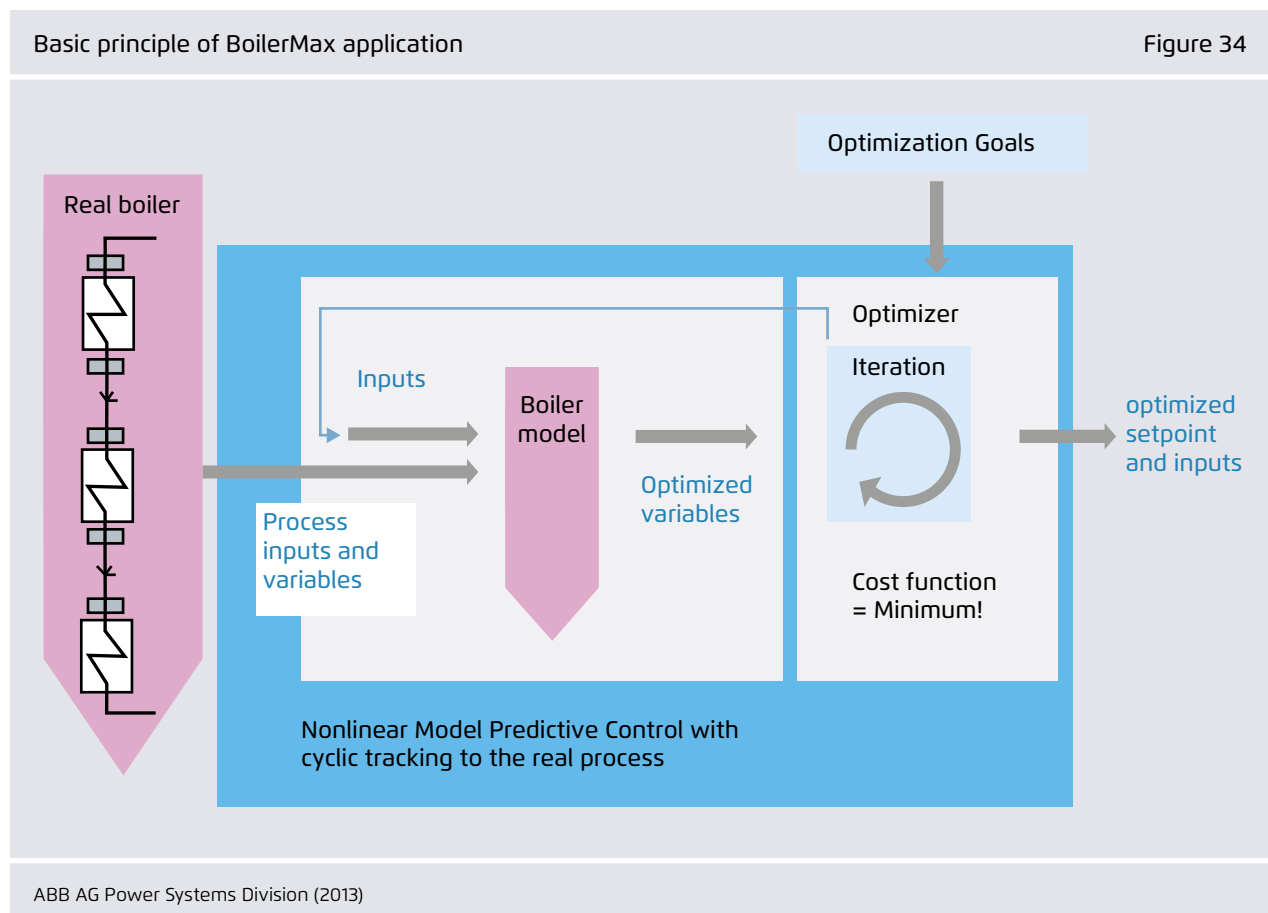

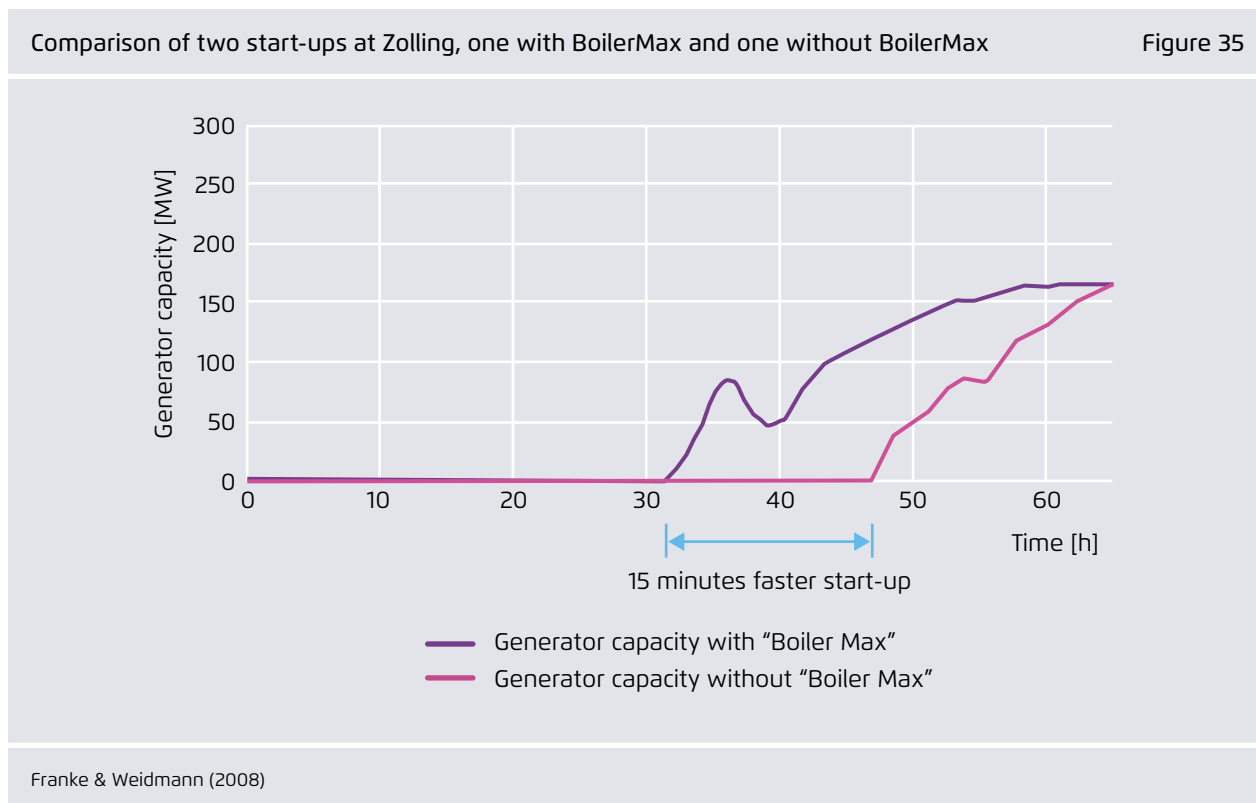

Option 3: Thin-walled components/special turbine design

The quicker a start-up, the faster the temperature of thick-walled components rises. Thermal stress on thick-walled components of the boiler system, such as headers, limits temperature fluctuations.¹⁹

For quicker start-ups, the wall thickness of thick-walled components needs to be reduced (Alstom, 2013). This can be achieved by using high-grade materials such as ferritic martensitic steel P92, which can better cope with thermal stress, or by using special designs.

When designing a power plant, future operators need to evaluate if they want the power plant to be more flexible or more efficient. Plant operators need to decide if they want power plant components to

be rather thick- or thin-walled. With thick-walled components, steam temperature and pressure can be higher than power plants that have thin-walled components. This increases efficiency but decreases flexibility. With a "thin-walled" component design, power plant flexibility is higher but efficiency decreases because steam temperature and pressure are lower.

Siemens new steam turbine, the SST5-6000, is designed for supercritical steam power plants with a power range between 600 and 1,200 MW per unit. A typical set consists of a four-casing arrangement with separate high pressure, intermediate pressure and two low pressure turbines. Smaller units (<500 MW), like the SST-5000, have also been designed with higher operational flexibility.

High parameter values (temperature and pressure) for steam require a specially designed turbine like the SST5-6000. The high pressure cylinder of the SST5-6000 is achieved using a bypass cooling

¹⁹ A header is a component in which steam is collected after having passed through the overheating phase in the boiler.

system. The turbine has a barrel-type construction with an inner casing. A small amount of cooling steam passes through radial bores into a small annulus between the inner and outer casings. The cooling steam is led through the inner casing, reducing the surface temperature. Lower surface temperatures reduce creep stress and protect the inner surface of the outer casing. In this way, the wall-thickness of the outer casing can be reduced for faster heat-ups and better start-up performance.

Such a turbine was installed in the Lünen power station, a hard coal-fired power plant in Germany with 750 MW of installed capacity. The total costs of this new power plant were 1.4 billion euros. Lünen started commercial operation at the beginning of 2014 (Trianel, n.d.).

Option 4: “New” turbine start

In most cases, steam turbine start-ups require a steam temperature that is higher than the metal temperature. Due to its mass, the steam turbine cools down fairly slowly. If the power plant has been out of operation for only a couple of hours, the restart must be delayed until the steam temperature reaches the turbine temperature.

In the past, steam turbine start-ups followed the static performance curves of the boiler and did not take ramp rates into account. As a result, the “hot” turbine hindered overall hot start performance.

To solve this problem, a new dynamic approach was introduced: allow “cold” steam to enter the steam turbine as quickly as possible after shutdown. This enables the turbine to start with the boiler while it’s still ramping up. This approach can reduce the hot start-up time by 15 minutes (Quinkertz, et al., 2008).

4.1.3 Options for increasing ramp rate

Recall why an increased ramp rate benefits power plant operation.

Reasons to increase the ramp rate

Power plant operators are interested in increasing ramp rates because it allows dynamic adjustments to net power. This is especially important in power systems with rising shares of renewables.

The previous two sections presented several retrofit options for reducing minimum load (Section 4.1.1) and start-up time (Section 4.1.2). As this sections shows, several of those retrofit options also have a positive impact on power plant ramp rate.

Option 1: Repowering

The repowering option, described in Section 4.1.2., has important implications for the ramp rate. Once again, repowering involves installing a gas turbine in a coal-fired power plant upstream of the water-steam circuit. Heat exchangers transfer the thermal energy in the exhaust stream from the gas turbine to the feed water.

Usually, the ramp rate is limited by the allowable thermal stress for thick-walled components. Additional limitations are caused by the fuel quality and the time lag between coal milling and turbine response present in the direct firing configuration.

In a normal coal-fired power plant, burning coal provides the only heat source for the water-steam circuit. With the repowering option, a second heat source can be used to pre-heat the feed water. This makes it possible to achieve a greater change in heat input per time, which translates into a faster ramp rate.

Figure 36 depicts the influence of the gas turbine on net power output. It shows the difference between

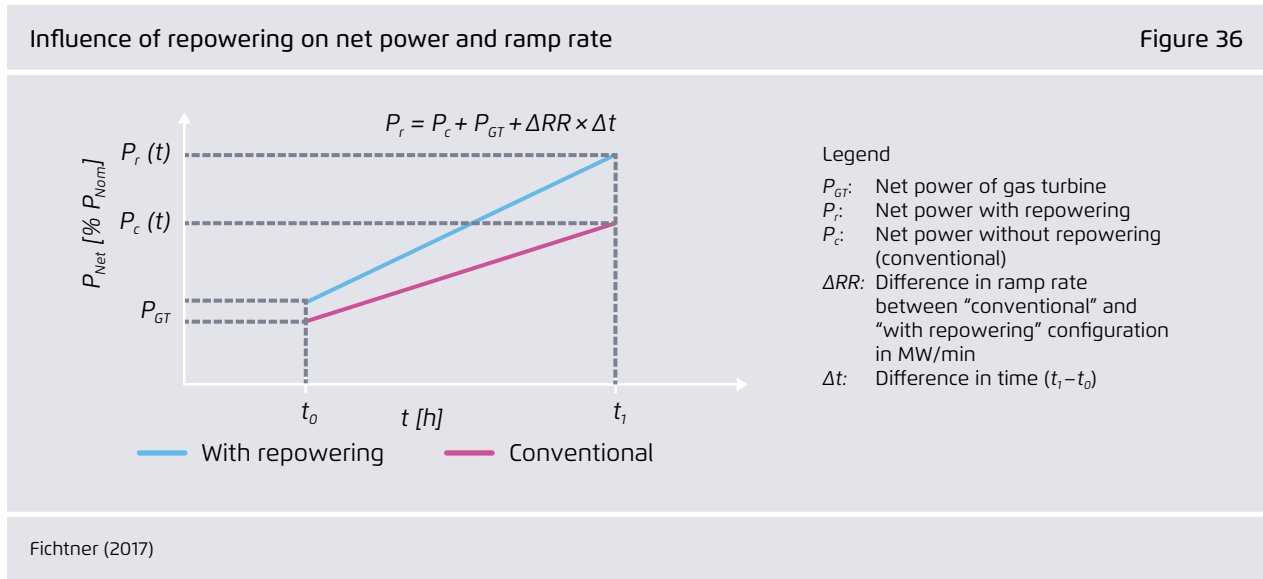

gas turbine repowering and a conventional configuration.

With repowering, the ramp rate is greater (hence the steeper slope) because an additional heat source is available to pre-heat the feed water. This means that after an equivalent period of ramping up a larger net power can be reached with the turbine than with the traditional configuration. The difference in net power between the two configurations is given by the net power of the gas turbine, P_{GT} , and the difference in ramp rate, ΔRR .

Option 2: Upgrading control systems and plant engineering

This option has already been described in Section 4.1.1. Here, the benefits of the retrofit on ramp rate are presented.

The retrofits at Weisweiler’s Unit G—a new digital control and communication system and upgrades to its plant engineering—not only reduced the minimum power; they also had a positive effect on the ramp rate. According to (Frohne, 2012), the ramp rate increased by 10 MW/min. The total retrofit at Unit G cost of 60 million euros.

(Schulze & Hoffmann, 2013) report that the ramp rate increased by 6 MW/min to 12 MW/min (2% P_{Nom}) as part of the Unit D retrofit at Neurath.

Option 3: Reducing the wall thickness of key components

As discussed earlier, the wall thickness of components is an important parameter because it influences the allowable temperature change rate. The temperature change rate describes the change in temperature per change in time at a specific location in the wall in Kelvin per minute, K/min. Since temperature changes induce thermal stress, each material is assigned a maximum allowable value. Exceeding this value reduces the material’s lifespan.

In general, reducing wall thickness increases the allowable temperature change rate. This translates into a faster start-up by boosting the ramp rate. Wall thickness can be reduced by using superior materials or by increasing the number of specific components, such as switching from a 2-line to a 4-line design (Jeschke, et al., 2012).

Research conducted by (Jeschke, et al., 2012) has shown that using a superior material such as Alloy 617 instead of P92 allows high pressure headers with

Influence of relative pressure on allowable temperature change rate in K/min for a high pressure header designed with two different materials

Figure 37

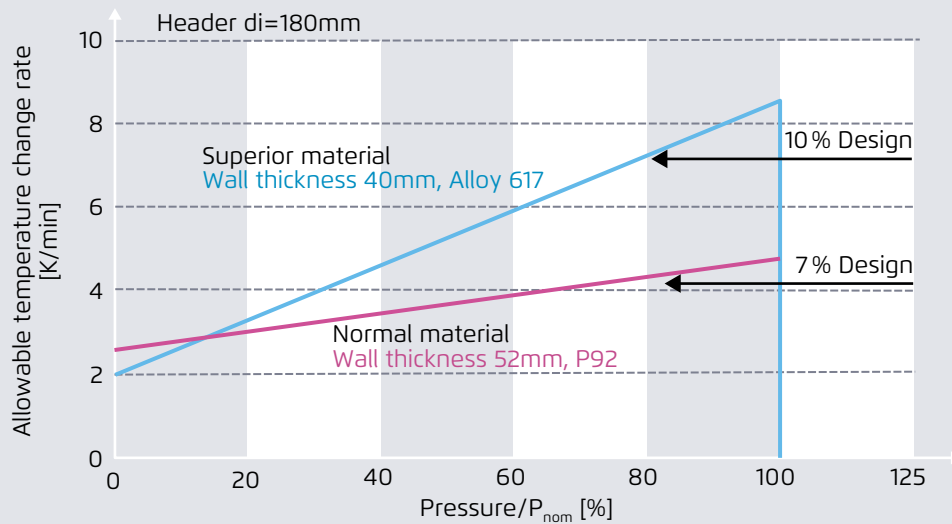

Fichtner (2016) based on Jeschke, et al. (2012)

23%-thinner walls. This increases the allowable temperature change rate by 60 percent in the load regime of 50–100 percent.

Figure 37 shows the influence of relative pressure on the allowable temperature change rate in K/min for a high pressure header using two different construction materials.

At 100 percent relative pressure—that is to say, at nominal operation—an allowable temperature change rate of about 8 K/min can be achieved when using Alloy 617 at a thickness of 40 mm. The difference from using P92 at a thickness of 52 mm results in an allowable temperature change rate of only about 5 K/min.

According to (Jeschke, et al., 2012), the use of the superior material would increase the plant's ramp rate by 3 percent.

Option 4: Auxiliary firing with dried lignite ignition burner in booster operation

The option of auxiliary firing with a dried lignite ignition burner was presented in Section 4.1.1 as means for decreasing the minimum load.

The ignition burner can also be used during operation to increase firing power and increase net power and ramp rate. This type of operation is referred to as booster operation. It requires a dust bunker to be independent of the inertia of the milling process (see Option 1 in Section 4.1.1)

Booster operation helps reduce time lag (partially caused by the milling process) between the rise in the firing rate and turbine response. Normally, the lag is around 20–60 s for hard coal-fired and 30–60 s for lignite-fired power plants (Scheffknecht, 2005).

4.2 Trade-offs between flexibility and efficiency

This section discusses the relationship between flexibility and efficiency of coal-fired power plants. In doing so, it answers a key question:

Key question:

“Do retrofits that aim to improve flexibility have a negative impact on power plant efficiency and, by extension, on specific CO₂ emissions?”

The section tracks the flexibility parameters described in this report: **minimum load, start-up time** and **ramp rate**.

1. Reducing minimum load

The minimum load is considered to be the most crucial flexibility parameter. Reducing the minimum load provides the power plant operator with a wider

range of possible net power outputs. It can also avoid expensive and CO₂-intensive shutdowns and start-ups.

In general, operating a thermal power plant in part load leads to lower efficiency relative to the nominal load. A decrease of efficiency translates into an increase of specific CO₂ emissions (g CO₂/kWh). Figure 38 illustrates this effect. Three operating points (OP) are depicted: the nominal OP, the minimum OP pre-retrofit and the OP post-retrofit.

The efficiency continuously drops the more operation is shifted from nominal conditions to part load. The effect of minimum load reduction is illustrated by the shift of the minimum operating point (from the lila to the pink dot). Reducing the net power output by about 20 percentage points ($\Delta P_{retrofit}$) decreases efficiency by about 2–5 percentage points ($\Delta \eta_{retrofit}$).

This effect translates into higher specific CO₂ emissions at very low load. However, when operat-

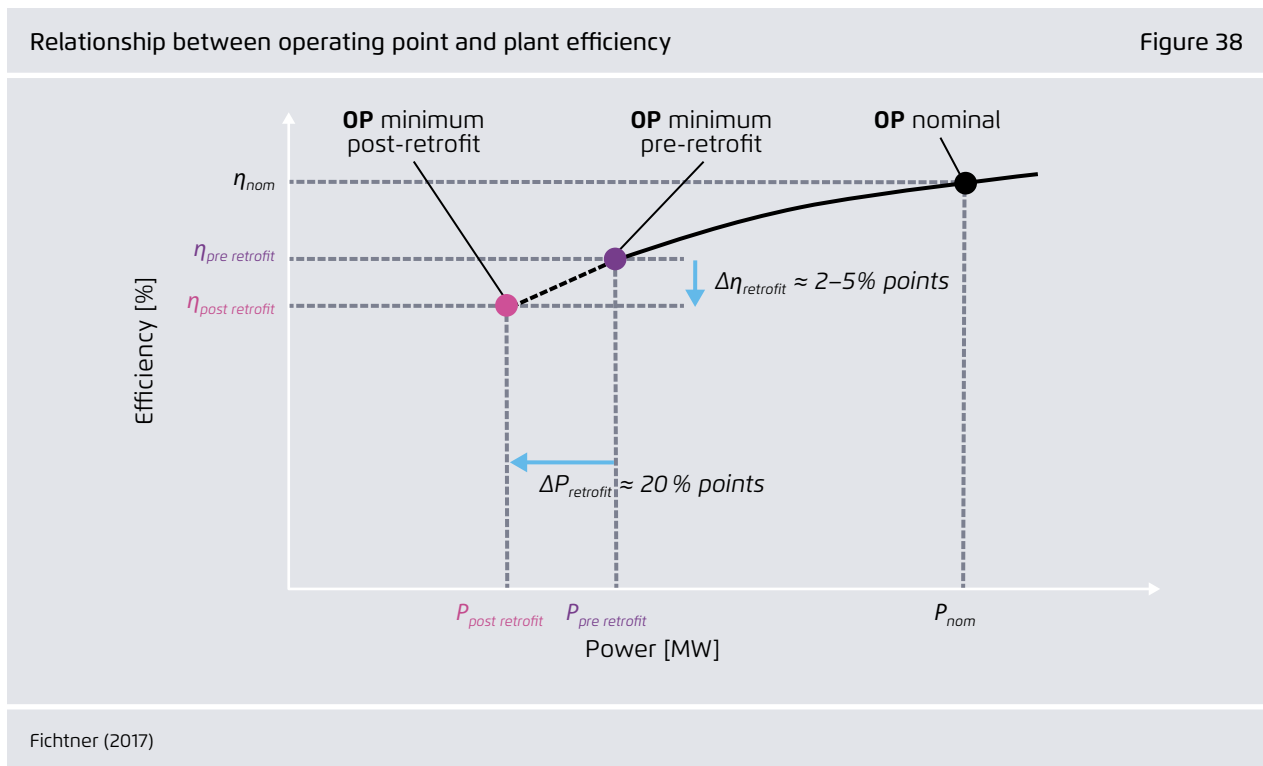

ing at a very low load, expensive and CO₂ intensive shutdowns and start-ups can be avoided. In addition, start-ups put strain on the components and reduce their life span. For instance, a hot start-up at a 750 MW hard coal-fired power plant requires approximately 1,820 MWh of thermal energy. This is about the same quantity required to operate the power plant at nominal load for approximately an entire hour. The fuel needed for the start-up translates into roughly 620 tons of CO₂ emissions. The associated fuel cost amounts to around 15,000 euros (at a coal price of about 30 euros per ton and excluding the cost for CO₂ certificates). It should be noted that a retrofit that decreases the minimum load has no effect on higher operating loads.

Given that the penetration of renewables such as wind and PV will continue to rise, fossil-fired power plants will be needed to respond quickly to changing power demand. From this perspective, it can be better to maintain low load operation than to shut down, since even a hot start for state-of-the-art hard coal-fired power plants takes between 80 minutes and 2.5 hours and leads to significant CO₂ emissions.²⁰

2. Reducing the start-up time

For each of the options reviewed, start-up time reduction measures were found to have no effect on efficiency.

3. Increasing ramp rate

For the options reviewed, increasing ramp rate had no negative effect on efficiency. In fact, repowering and other measures actually improved overall plant efficiency.

Summary

Retrofit measures do not have a negative effect on efficiency.²¹ In many cases, retrofits to increase flexibility improved plant efficiency. (See Options 1, 3, 4 of Section 4.1.1 and Option 1 of Section 4.1.2.)

However, lowering the minimum load can reduce the efficiency of the power plant at very low load, increasing specific CO₂ emissions at low load operating points. To measure this effect fully, CO₂ emissions must be assessed over the power plant's entire operation instead of focusing on the lowest operating points. All in all, the flexibility gained by thermal power plants outweighs in most cases the drawbacks of CO₂ emissions at low operating points, and this advantage will only grow as the share of renewables increases. These effects will be discussed in more details in section 5.2.

²⁰ In a case-by-case evaluation, the effect of decreasing minimum load on a single plant can increase absolute CO₂ emissions due to increased usage and improved market competitiveness post-retrofit. This is discussed in more details in section 5.2.3.

²¹ The designers of new power plants face, however, a conflict between flexibility and efficiency. Achieving high efficiency at nominal load means generating high-temperature and high-pressure steam. Components such as headers must have a certain thickness to handle these conditions. This reduces the allowable temperature change rate, reducing power plant flexibility.

4.3 Potential and limitations of flexibility retrofits

Flexibility retrofits are an important way of modifying coal-fired power plants for increasingly volatile power demand.

This section assesses the potential and limitations of flexibility retrofits for coal-fired power plants. Table 5 summarizes the retrofit options discussed in Section 4.1 and shows the key flexibility parameters that improved as a result of their implementation.

Minimum load reduction, decreasing start-up time and increasing ramp rate are discussed separately in this section. The material is then summarized at the end.

1. Reducing minimum load

The increasing volatility of feed-in from renewable energy sources leads to more frequent start-ups and shutdowns of coal-fired plants and other conventional power stations (Balling, 2010). Traditionally, coal-fired power plants, especially lignite-fired ones, have been designed for base load operation. A more flexible operation schedule puts more strain on components and necessitates more start-ups, which are energy- and CO₂-intensive (Section 4.2).

Minimum load reduction retrofits have clear potential. They can reduce the number of start-ups and shutdowns by allowing the power plant to stay online at very low loads. Even though efficiency in part load, especially when loads are very low, is lower relative to operation at nominal load, CO₂ emissions can be avoided because of the reduced number of

Summary of analysed retrofit options, their effect on flexibility parameters and their limitations Table 5

Option	Minimum load	Start-up time	Ramp rate	Limitations
Indirect Firing	✓		✓	Fire stability
Switching from two-mill to single-mill operation	✓			Water-steam circuit
Control system and plant engineering upgrade	✓		✓	Fire stability/ thermal stress
Auxiliary firing with dried lignite ignition burner	✓		✓	Fire stability and boiler design
Thermal energy storage for feed water pre-heating	✓			N/A
Repowering		✓	✓	N/A
Optimized control system		✓		Thermal stress
Thin-walled components/special turbine design		✓		Mechanical and thermal stresses
“New” turbine start		✓		Turbine design
Reducing wall thickness of key components			✓	Mechanical and thermal stresses

Fichtner (2017)

start-ups.²² Furthermore, flexible operation yields a higher penetration rate of renewables without compromising grid stability. This, in turn, reduces the CO₂ emissions of the power system generally (see section 5.2).

The limitations of minimum load reduction are usually posed by the fire stability in the boiler, as described in Section 4.1.1. Currently, the minimum load of state-of-the-art hard coal- and lignite-fired power plants lies between 25–40 % and 35–50 %. In case of extremely low load operation (such as the 12 % of P_{Nom} achieved with single-mill operation in Bexbach and Heilbronn Unit 7), the limitations are

²² In a case-by-case evaluation, the effect of a decreasing minimum load for a single plant can increase absolute CO₂-emissions because of increased usage and improved market competitiveness after retrofit.

caused by the water-steam circuit described in Section 4.1.1.

Table 6 provides a summary of the potential and limitations of each retrofit option. For a detailed description of all options for minimum load reduction, please refer to Section 4.1.1.

2. Reducing start-up time

Due to the increased share of fluctuating power feed-in from renewables, the number of start-ups and shutdowns in coal-fired plants and other conventional power stations is expected to rise.

Start-ups and shutdowns are energy intensive, require expensive ignition fuels (such as heavy oil and gas) and put a high level of strain on components. Decreasing the start-up time reduces the need for

Potential and limitations of retrofit options for reducing minimum load

Table 6

Option	Potential	Limitations
Indirect firing	A reduction of minimum stable firing rate from 25–30 % to 10 % (with burner retrofit) was achieved (Jeschke, et al., 2012). This leads to a corresponding reduction in minimum load.	Fire stability
Switching from two-mill to single-mill operation	On average, these retrofits reduced minimum load from 23 % to 12 % of P_{Nom} (Heinzel, et al., 2012).	Water-steam circuit
Control system and plant engineering upgrades	On average, these retrofits reduced minimum load from 71 % to 47 % of P_{Nom} . The total cost of the retrofits at units G and H at Weisweiler amounted to 60 and 65 million euros, respectively. At Neurath the total cost of the retrofit at unit E amounted to 70 million euros (RWE Power AG, 2012), (Frohne, 2012), (Schulze & Hoffmann, 2013).	Fire stability
Auxiliary firing with dried lignite ignition burner	This option reduced the minimum load from 36 % to 26 % of P_{Nom} (Michels, 2016).	Fire stability
Thermal energy storage for feed water pre-heating	A reduction of minimum load by 5–10 % employing a hot water storage system that can operate for 2–8 hours is deemed realistic (Schmidt & Schuele, 2013).	N/A

Fichtner (2017)

Potential and limitations of retrofit options for reducing start-up time			Table 7
Option	Potential	Limitations	
Repowering	In general, repowering has a positive influence on start-up behaviour, as the gas turbine can ramp significantly faster (Jeschke, et al., 2012). The implementation of two gas turbines at Units G and H at Weisweiler with 190 MW each (31% of P_{Nom} of the coal unit) increased net power by 80 MW (+6.6 P_{Nom}) per unit. The total investment amounted to 150 million euros.	N/A	
Optimized control system	This retrofit reduced start-up time by 33% (15 minutes) (Franke & Weidmann, 2008).	Thermal stress	
Thin-walled components/ special turbine design	Utilizing superior materials allows for thinner walls in components such as headers. Thinner walls allow faster start-ups.	Mechanical and thermal stresses	
“New” turbine start	This retrofit reduced the hot start-up by 15 minutes (Quinkertz, et al., 2008).	Turbine design	

Fichtner (2017)

Potential and limitations of retrofit options for increasing ramp rate			Table 8
Option	Potential	Limitations	
Repowering	Repowering has been shown to increase ramp rates. Modern power plants achieve ramp rates of up to 6% P_{Nom} /min.	N/A	
Control system and plant engineering upgrade	These retrofit options increased ramp rates by +6 MW/min (600 MW P_{Nom}) and +10 MW/min (600 MW P_{Nom}) at Neurath and Weisweiler (Frohne, 2012), (Schulze & Hoffmann, 2013). The total cost of the retrofits are given in Table 6.	Thermal stress	
Reducing the wall thickness of key components	This retrofit increased the ramp rate by 3% (Jeschke, et al., 2012).	Mechanical and thermal stresses	
Auxiliary firing with dried lignite ignition burner in booster operation	Increasing the firing rate at constant boiler load with booster operation has potential for rapidly increasing net power (Michels, 2016).	Boiler design, booster operation	

Fichtner (2017)

those fuels because a stable fire with pulverized coal can be achieved faster. In addition, plant operators can reduce their response time to power demand in case of plant standstill.

The limitations are mainly caused by the allowable thermal and mechanical stress for thick-walled components such as headers. Table 7 provides a summary of the potential and limitations of each retrofit option. For a detailed description of all options for start-up time reduction, see Section 4.1.2.

3. Increasing ramp rate

Increasing ramp rate is particularly important for grid stability given increasing shares of fluctuating renewable feed-in. The faster generating units can adjust their net power, the easier it becomes for (grid) operators to balance supply and demand.

The major limitations for increased ramp rates are caused by thermal and mechanical stress during ramping. This stress reduces component life and must be accounted for during component design. Generally, there is a trade-off between thick-walled design for high efficiency and thin-walled design that permits a higher temperature change rate and therefore higher ramp rates.

Table 8 provides a summary of the potential and limitations of each retrofit option. For a detailed description of all options for increasing ramp rate, see Section 4.1.3.

Conclusion

Retrofits for increasing flexibility were performed at numerous coal-fired power plants in recent years. These retrofits significantly improved the flexibility

Major coal-fired plant subsystems where retrofits were performed to improve flexibility

Figure 39

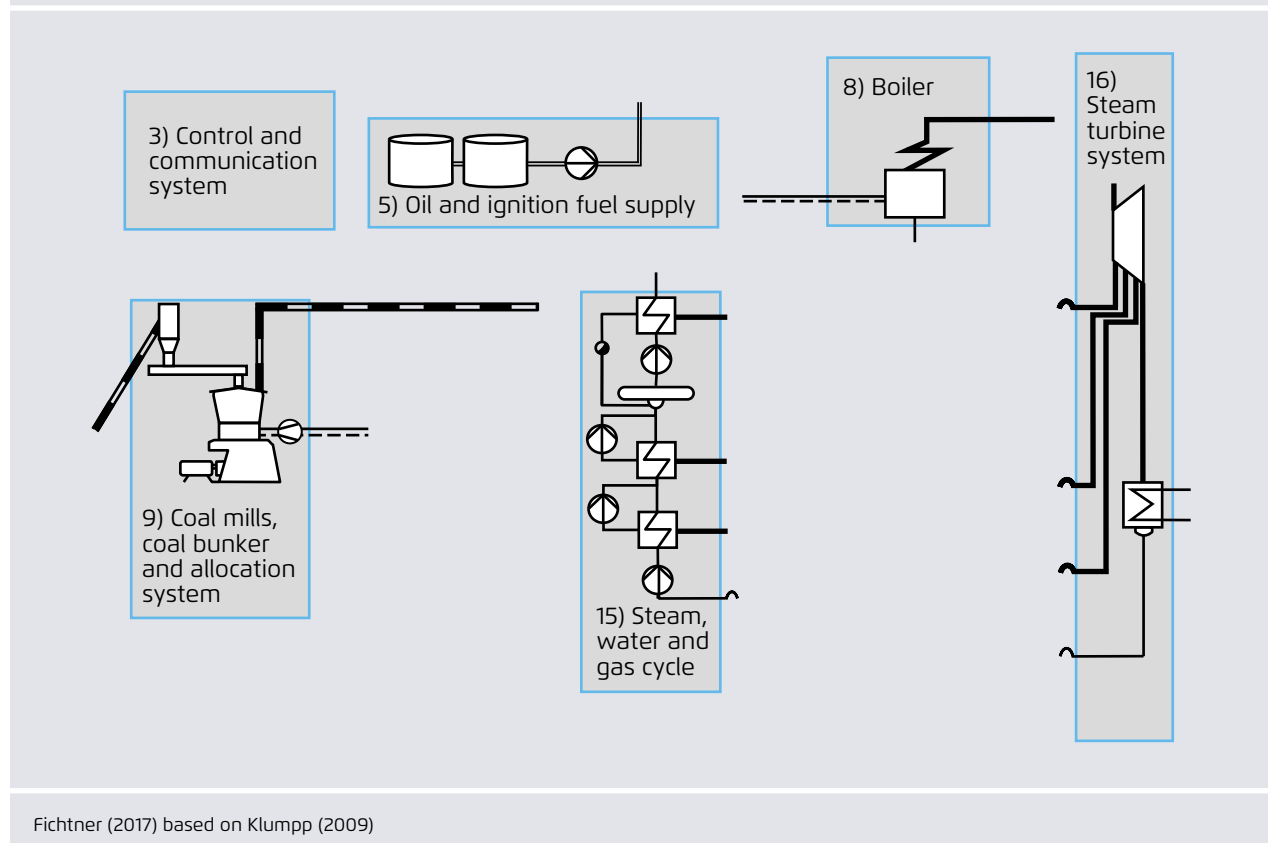

Fichtner (2017) based on Klumpp (2009)

of coal-fired power plants with regard to minimum load, start-up time and ramp rate. Besides improving flexibility, the retrofits mostly had a positive influence on plant efficiency, which lowered specific CO₂ emissions.

Figure 39 summarizes the major subsystems where retrofits were performed to improve flexibility.

Most retrofits can be implemented independently of coal type or ash removal system. The main limitations to flexibility improvements are caused by boiler fire stability and by the allowable thermal stress on components. But meaningful improvements can nevertheless be attained within the boundaries of these limitations.

Few retrofit options portrayed in Section 4.1 provide information about financial expenditures. In terms of economic viability, each retrofit has to be analysed on a per plant basis. Generally, it is not possible to say whether a retrofit will be economically viable without knowing the role of the power plant within the electricity mix, within the electricity market and within the country-specific energy road map. This dimension will be further assessed in the next section.

Impact of flexibility on Power Plant Profitability and CO₂ Emissions and Country Profiles South Africa and Poland

WORK PACKAGE 3

WRITTEN BY

Prognos AG
Europäisches Zentrum für Wirtschaftsforschung
und Strategieberatung
Goethestraße 25
10623 Berlin
Telephone: +49 (0)30 52 00 59-200
Fax: +49 (0)30 52 00 59-201
www.prognos.com

Contributing authors:

F. Ess
Telephone: +41 (0)61 32 73-401
Email: florian.ess@prognos.com

F. Peter

prognos 

5. The Impact of Flexibility on Power Plant Profitability and CO₂ Emissions

5.1 Flexibility impacts on power plant operations

As discussed in section 2, power systems with significant shares of renewable generation require more flexibility to cope with fluctuating generation. If markets are adequately designed, flexibility needs are reflected in electricity prices at the wholesale level.

The structure and functioning of electricity markets varies from country to country. Electricity markets generally comprise long-term (derivative) markets, day-ahead markets and intraday markets. These markets segments are complemented by markets and arrangements for ancillary services (i.e. in order to maintain system stability in real-time). Flexible generation capacities are able to earn revenues, depending on their specific characteristics, in day-ahead and intraday markets as well as in markets for ancillary services. However, day-ahead markets currently account for the majority of the volume of all market segments and have the greatest impact on power plant operations and revenues.

Most day-ahead markets are currently based on a marginal-cost approach. Since renewables have low or almost zero marginal costs, electricity prices tend to be significantly lower when renewable generation is high (due to the so-called Merit-Order Effect discussed in section 2).

Taking this into consideration, an increasing share of renewables and low residual load will lead to more times with low or even negative electricity prices at the wholesale level. Conventional power plants are thus encouraged to avoid operation during times with negative prices or when prices fall below the plant's marginal operating costs in order to limit losses.

If plants have to stay in the market (e.g. to provide system services), more flexibility has direct economic value for the operator. Moreover, switching off a power plant entails start-up costs. Therefore, a trade-off exists between avoiding losses from negative prices and the costs associated with start-up.

The following example illustrates the revenue effects of increased coal power plant flexibility. It assumes the plant is selling electricity in a marginal-cost-based day-ahead market. We additionally assume a power system with a significant share of renewables but with a considerable volume of conventional generation from thermal power plants.²³

Figure 40 illustrates two coal power plants with different flexibility characteristics but the same efficiency standards. The solid line represents a coal power plant without retrofitting and limited flexibility. In comparison, the dashed line represents a coal power plant with retrofitting and improved flexibility characteristics, namely higher ramp-rates and lower minimum load. Because of high shares of renewable generation, the power plants face periods of low and even negative electricity prices.

Table 9 shows the characteristics of a typical coal fired power station, constructed during the 1970s in Europe, with and without increased flexibility following retrofitting. The assumptions for the illustrative CCGT plant, constructed in the 1990s, is required for the later analysis of CO₂ emissions (see section 5.2).

²³ Additional revenues for power plants from increased flexibility can also be derived from intraday markets and balancing power markets. However, day ahead markets are usually responsible for more than 80 % of the revenues of a coal fired power station.

Plant parameters and market environment for the following illustrative examples

Table 9

Plant specification	Hard coal Limited flexibility	Hard coal Increased flexibility	CCGT
Unit nominal capacity	600 MW	600 MW	600 MW
Minimum load in % of nominal capacity	40%	25%	40%
Minimum load in MW	240 MW	150 MW	240 MW
Net efficiency at nominal load	40%	40%	52%
Net efficiency at minimum load	34.5 %	31 %	40 %
Start-up-costs in euro/MW	80	80	40
Specific CO ₂ emissions of fuel in g/kWh _{th}	330	330	202
Variable operation costs in euro/MWh _{el}	2.0	2.0	1.0
Start-up-time hot start in h	2	2	1
Market environment			
Fuel price in euro/MWh _{th}	10	10	15.8
CO ₂ price in euro/tonne	10	10	10
Marginal generation costs in euro/MWh_{el}	35.3	35.3	35.3

Assumptions and calculations from Prognos

Figures 41 to 44 illustrate the economic effects of more flexible operation. To assess power plant economics, we consider profit margins, total generation costs and specific generation costs during an illustrative time span of 48 hours with a typical hourly price formation for markets with large shares of renewable energy.²⁴

a) Inflexible generation

Figure 41 illustrates the operation of an inflexible coal power plant. Due to its limited flexibility in “must run” operation, the plant has to stay in the market and experiences losses during times with low or negative prices. The following example was calculated for a power plant based on the parameters and market environment summarised in Table 9.

Because the minimum load of the plant is limited to 40 percent, it only realises a profit margin of 46,800 euros, and suffers losses during times of low or negative prices. Specific generation costs reach 36.70 euros/MWh.

²⁴ Profit margin equals total generation costs minus total earnings from the electricity sales. The total generation costs include the marginal costs of operation and the costs for starting the power plant, fixed costs are not considered. The specific generation costs are derived from the ratio of the total generation costs and the electricity produced in that observed 48 hours.

Hard coal power plant operation before and after retrofitting with lower minimum load, increased ramp rates and reduced start-up time in a 48-hour example period

Figure 40

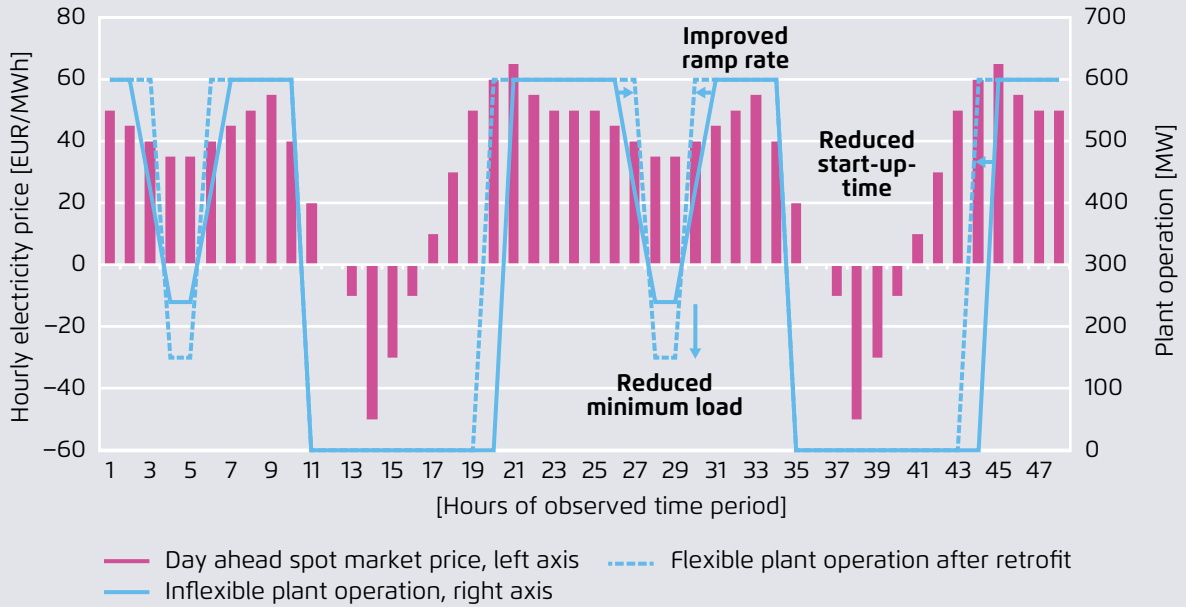

Prognos (2017)

Hard coal power plant in must-run operation in a 48 hour example period

Figure 41

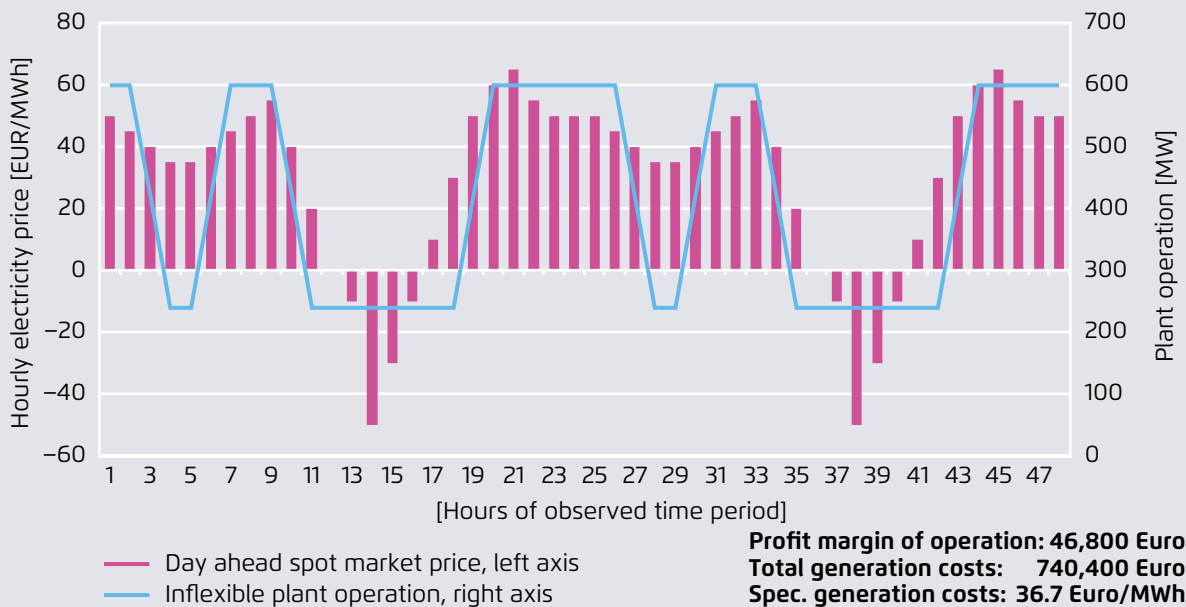

Prognos (2017)

Hard coal power plant with temporary shut-down in a 48 hour example period

Figure 42

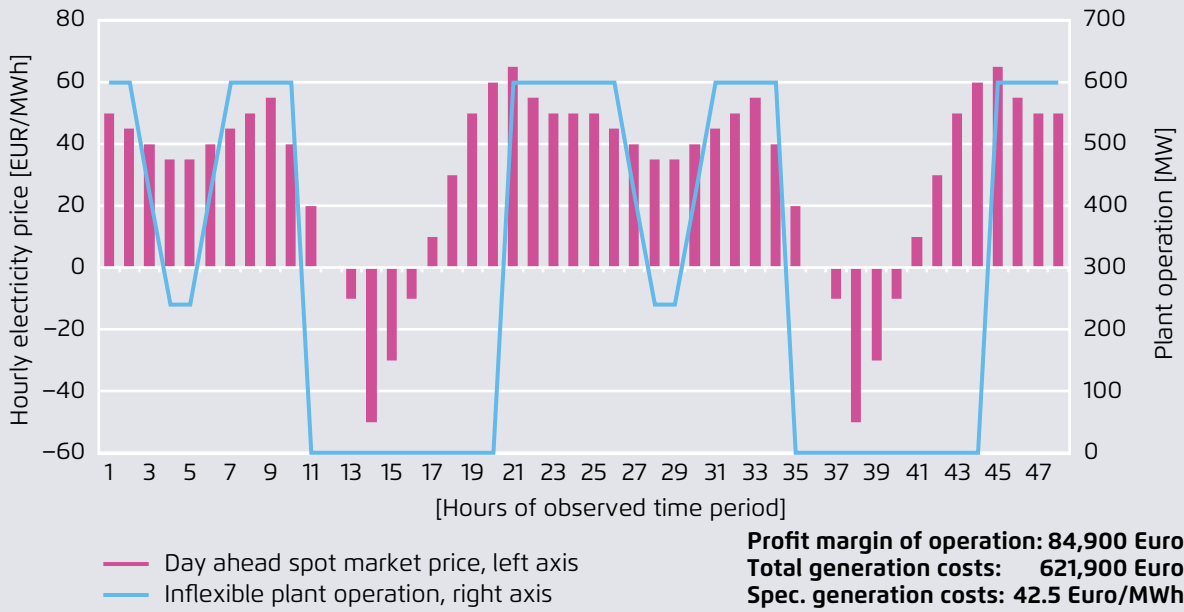

Prognos (2017)

Hard coal power plant with lowered minimum load and increased ramp rates in must-run operation in a 48 hour example period

Figure 43

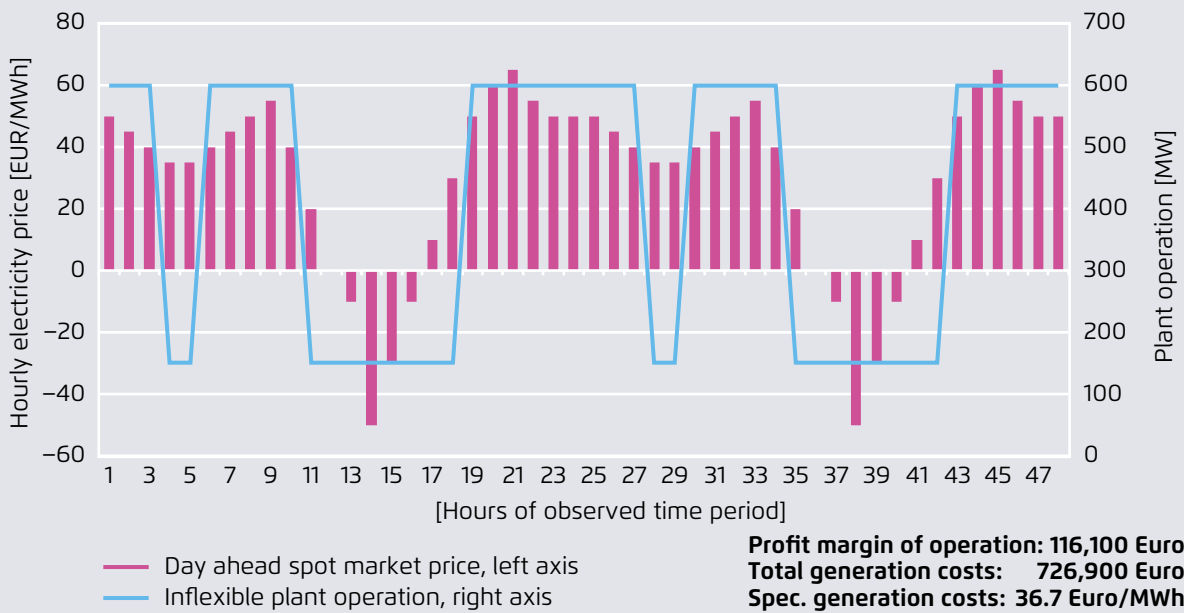

Prognos (2017)

b) No must-run but limited flexibility

If the plant is able to shift to a more flexible mode of operation, the first possible approach would be to avoid negative prices and shut down temporarily during times with negative prices. However, the plant loses part of its earnings due to shut-down and start-up times. Figure 42 illustrates the same power plant in a more flexible mode of operation with temporary shut-down during times of negative prices.

Because losses during times of negative prices can be avoided, the profit margin increases to 84,900 euros, while specific generation costs also increase to 42.50 euros/MWh due to additional start-up costs. The trade-off between avoiding losses from negative prices and reduced revenues during times of start-up and shut-down highlights the benefits of operation at lower minimum load levels and of improved ramp rates.

c) Higher operational flexibility with must-run condition

Furthermore, some conventional plants have to stay in operation because of their relevance for system services or heat supply ("must-run" conditions). In this situation, reducing the minimum load is a key solution for optimising power plant earnings while limiting losses. Reducing minimum load can be achieved with a range of retrofit measures, which are described in section 4. Figure 43 illustrates the case of a coal power plant that is able to reduce its minimum load to 25 percent of its nominal capacity while also increasing its ramp rate.

As Figure 43 shows, in must-run operation the total profit margin is 116,100 euros, a figure that is considerably higher than profits before retrofitting because the plant is able to generate additional earnings during some hours after the price drop. In comparison to Figure 41 (with higher must-run operation), the plant is also able to limit its losses in times of negative prices because of its ability to operate with a reduced minimum load. The specific generation costs are lower compared to the case with two starts because

the two starts can be avoided. The overall generation costs are lower compared to the must-run case because overall less fuel is used during times of minimum load operation even when considering the lower efficiency in low load operation. Such an operation pattern could also be the result of measures to optimise the market. This would be the case, for example, if the losses incurred from negative prices do not exceed the costs of an additional start.

d) Flexible operation without must-run

Figure 44 shows the optimal dispatch of a retrofitted power station when no must-run scheme is enforced. The reduced minimum load mitigates losses during times of negative prices. The increased ramp rate and the reduced start-up time leads to more flexible operation compared to a plant with weaker flexibility characteristics. The profit margin (122,160 euros) is the highest of the analysed cases, but the gap gradually decreases, and is rather small compared to flexible operation under must-run conditions (116,100 euros).

As can be seen from this example, the decision to run a plant using a flexible mode of operation depends on the earnings associated with more flexible operation. Therefore, to allow power plant operators to fully harness the benefits of flexibility, market conditions have to be designed adequately (see subsection 5.3).

From this analysis, some preliminary conclusions can be drawn: When implemented in a market environment with high shares of renewables and wholesale markets based on marginal costs, increasing the flexibility of a thermal power plant improves the economic situation of the plant, as compared to inflexible operation.

- Reducing minimum load is the measure with the most positive profitability impact for a thermal power plant in most cases.
- The question whether a specific flexibility investment is profitable or not cannot be answered in

Hard coal power plant with lowered minimum load and increased ramp rates and shorter start-up time in a 48 hour example period

Figure 44

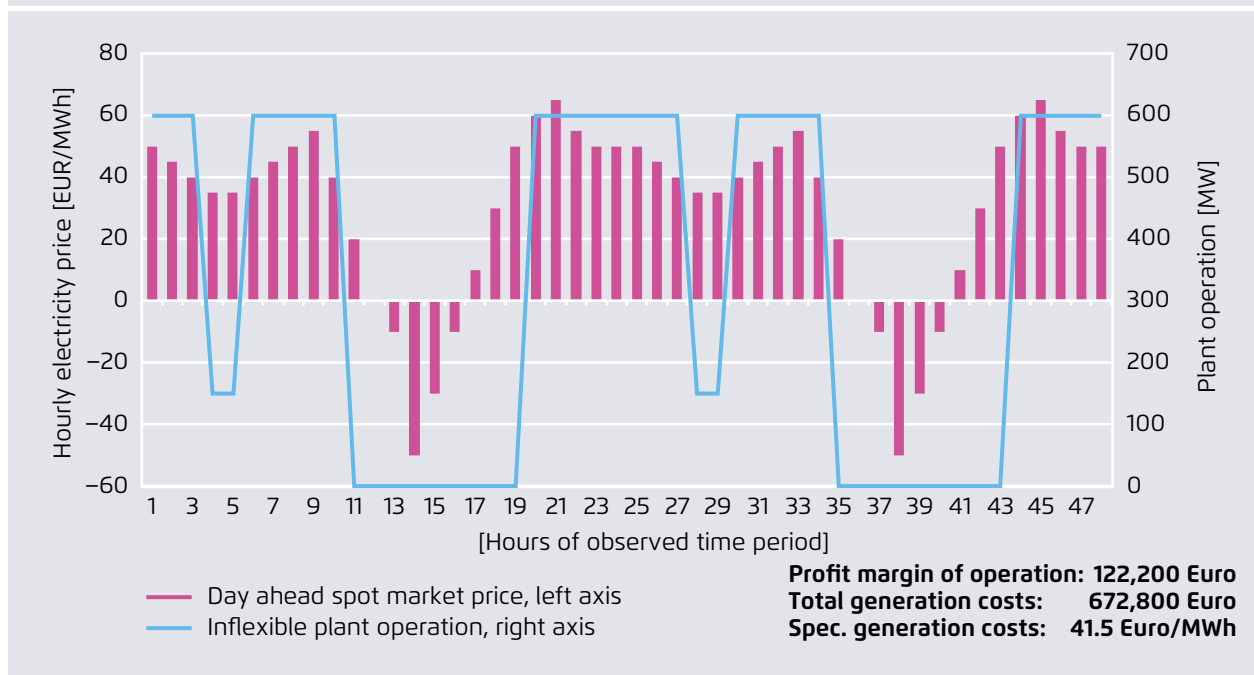

Prognos (2017)

general. Specific plant parameters and market environments (e.g. age of the plant, renewable shares, general market design, remuneration options for flexibility) require a case-by-case determination.

5.2 Effects on CO₂ emissions

The flexible operation of coal power plants due to an increased share of renewables also influences plant-specific CO₂ emissions (since power plants face lower full-load hours and are more often operated at partial loads). In general, coal power plants produce more CO₂ emissions per unit of output compared to other forms of conventional power generation (e.g. natural gas power plants). However, the key question is whether the flexible operation of coal power plants contributes to an overall reduction in CO₂ emissions in the economic and political environment of a specific country.

The CO₂ emissions of a power plant are crucially determined by the type of fuel used. A proper approach for measuring emissions is to assess the overall life-cycle greenhouse gas emissions of the fuel in question. Those emissions depends on the type of fuel, extraction techniques, and supply routes (see 5.2.1). The emissions released specifically by the power plant depends on its efficiency (the higher the efficiency, the lower the emissions). Furthermore, this efficiency varies when the power plant is operated at partial loads. This aspect is discussed in section 5.2.2. Finally, in order to compare the emissions of different technologies (e.g. flexible coal versus CCGTs gas power plants), the technologies must be compared under similar dispatch conditions. An illustrative example is given in section 5.2.3.

Specific CO₂ emissions for a range of fuels

Table 10

Fuel	Natural gas	Hard coal	Lignite
Range of specific emissions [gCO ₂ /kWh _{th}]	202–300	325–350	340–410
Lower limit specification	Pipeline gas	Bituminous coal	Pulverised lignite
Upper limit specification	Shale gas	Anthracite	Raw lignite

Prognos (2017)

5.2.1 Life-cycle emissions of different fuels

The greenhouse gas emissions of power plants are not only a consequence of burning fuel (whether coal, natural gas or oil), but depends also on the overall life cycle emissions of each specific fuel. Overall life cycle emissions depend on the following aspects:

- exploration and extraction technology,
- fuel processing and transport,
- use of the fuel (e.g. power generation) and post-production processes.

Depending on these parameters, the CO_{2,eq} content of the fuel can vary significantly, as shown in table 10. As can be seen, lignite and hard coal have in general higher life-time greenhouse gas (GHG) emissions than natural gas. However, natural gas has a broader range of associated GHG emissions content, varying from 200 to 300 g CO_{2,eq}/kWh_{th}, depending on the types of gas and extraction techniques (shale gas, LNG, pipeline gas, etc.). The CO_{2,eq} content of shale gas is about 50 percent higher than that of pipeline gas, positioning shale gas close, but still below, bituminous hard coal (325 g CO_{2,eq}/kWh_{thermal}). The CO₂ content of pipeline gas is, however, far below that of coal (both hard coal and lignite).

5.2.2 Effect of partial loads on CO₂ emissions

In section 4.2, we discussed the relationship between partial load operation and the efficiency of a power plant. The efficiency of a power plant (as a percentage) indicates how much electric energy (kWh_{electric}) is produced from the total energy content of the fuel (kWh_{thermal}). The rate of efficiency varies depending on the operational mode of the power plant. It is highest at the plant's nominal load and decreases when the plant operates at partial loads. This leads to an increase in the specific CO₂ emissions (gCO₂/kWh) of the power plant at low load levels, as illustrated in the following figure. It must be noted, however, that this efficiency drop only occurs during partial load operation. It does not represent the average efficiency of the plant over the full year (which is likely to be much closer to the efficiency at nominal load).

As can be seen in Figure 45, the net efficiency of a typical older coal power plant (40 percent) at nominal load is considerably lower than the net efficiency of a CCGT (52 percent). This implies that the specific CO₂ emissions for the coal plant are considerably higher at nominal loads. However, the efficiency of a CCGT falls much more significantly than the efficiency of a coal power plant when it operates at very low load levels (in this example, minus 12 percentage points for the CCGT versus 5.5 percentage points for the coal power plant).

Relationship between plant output and efficiency of hard coal and CCGT gas power plants (600 MW nominal power) at different operating points (illustrative)

Figure 45



Agora Energiewende based on assumptions from Table 9

5.2.3 Comparing CO₂ emissions of different technologies under similar dispatch

In systems with an increasing share of renewables, the yearly utilisation hours of coal power plants is reduced, moving from pure baseload operation (above 7,000 hours) to more mid-merit operation (between 4,000 and 7,000 hours).²⁵ This can reduce the overall emissions of the power plant (since it produces less power). This development makes coal power plants competitive with CCGT gas power plants. Therefore, a key question is whether coal power plants under flexible operation emit more or less emissions

than CCGT gas power plants.²⁶ In order to meaningfully compare the CO₂ emissions of different power plants, we need to assess their operation under similar dispatch conditions, but with different flexibility parameters, while also taking into account variation in efficiency as a function of the load at any given time.

Considering the above, we conducted a comparison of conventional power plants using different fuels. In the following example, the CO₂ emissions from a coal power plant (using hard coal) are compared with the CO₂ emissions of a CCGT power plant.

²⁵ In reserve operation schemes (e.g. strategic reserves) the annual utilization of coal fired power stations can drop even further. However, the need for flexible plant characteristics still exists with such schemes.

²⁶ As shown in table 10, the specific emissions of CCGT power plants are in the same range as those of coal power plants. A more detailed comparison of the overall emissions released by these two technologies is not particularly relevant in the present context, however, as CCGTs have a rather different function in the power system. As peak power plants, their utilization rates are limited to several hundred hours a year.

We considered different operational modes, both with or without must-run levels. For the coal power plants we also considered two operational modes, without retrofitting (limited flexibility) and after retrofitting (increased flexibility). Table 9 shows the technical parameters and other general assumptions for this specific example. Because the marginal costs of both plants are equal within the chosen framework, CCGT plant operation mirrors coal plant dispatch, but has a shorter start-up time and faster ramp rate (see figure 46).

Given the market conditions shown in Figure 46, we obtain the following results over a 48 hour period:

→ (a) In must-run operation (without retrofitting), the cumulative CO₂ emissions of the coal power plant are 17.4 kt, whereas the emissions of the CCGT plant are 9.0 kt (pipeline gas) or 13.3 kt (shale gas).

→ (b) Without must-run (two stops), but with limited flexible operation, the CO₂ emissions of the coal power plant are reduced to 15.4 kt. Each start-up procedure is emissions-intensive, significantly increasing the CO₂ emissions per kWh of electricity produced. However, since the plant is offline for several hours, cumulative emissions are lower.

→ (c) In must-run but flexible operation (the must-run level is reduced accordingly to 150 MW), the coal power plant emits 17.0 kt, compared to 7 kt (pipeline gas) or 10.4 kt (shale gas) for the CCGT unit.

→ (d) After retrofitting (which enables increased ramp rates, lower minimum loads and reduced start-up times), the coal power station generates more electricity in the example 48 hour period (16,200 MWh), almost equalling the output of the

CCGT operation versus hard-coal plant operation in a 48 hour example period

Figure 46

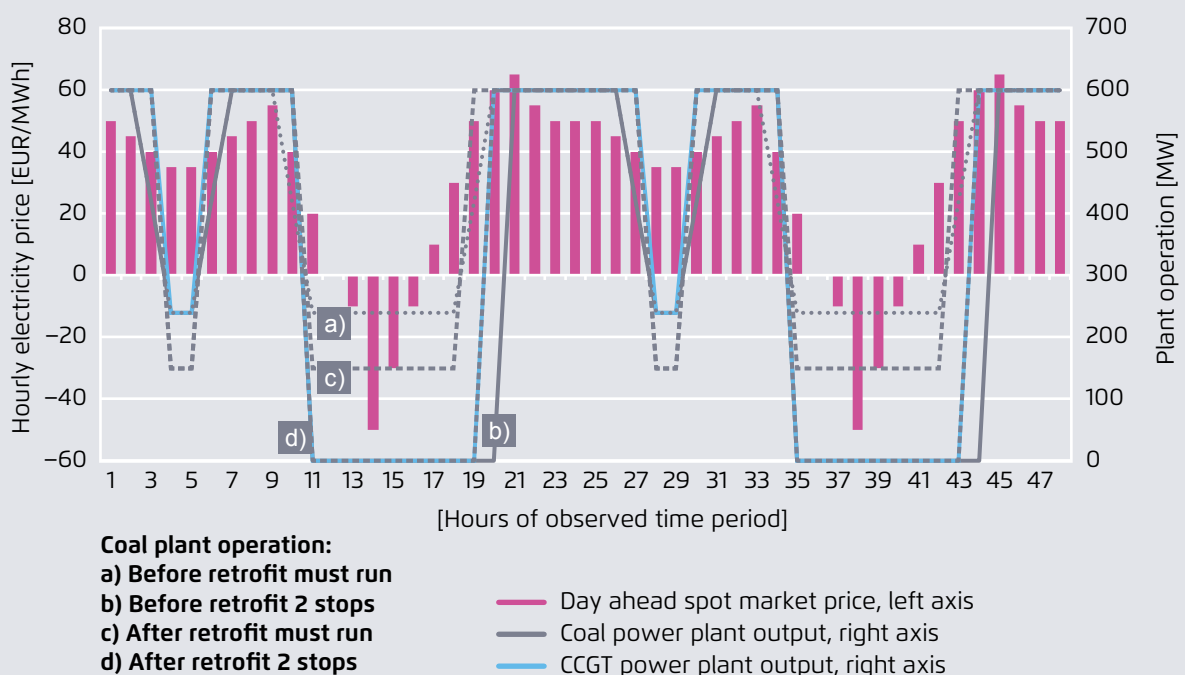

Prognos (2017)

CO₂ emissions of CCGT and hard coal power plants under similar dispatch conditions but with different flexibility features during 2 example days

Figure 47

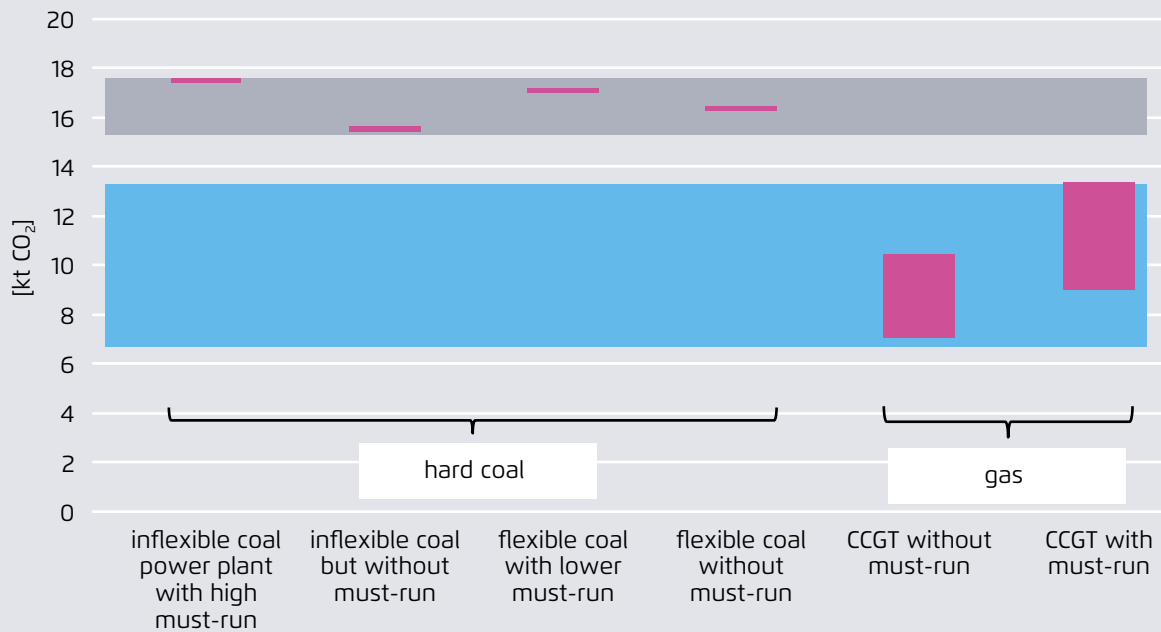

Agora Energiewende based on Prognos

CO₂ emissions for CCGT and hard coal fired power stations in different operational modes (data from Figure 47)

Table 11

Plant type and operation mode	Electricity production in MWh	CO ₂ emissions in tonnes	Specific CO ₂ emissions in g/kWh _{el}
Hard coal no retrofit must-run	20,160	17,369	862
Hard coal retrofit must-run	19,800	17,054	861
CCGT must-run using shale gas	21,600	13,336	617
CCGT must-run using pipeline gas	21,600	8,980	416
Hard coal no retrofit 2 stops	14,640	15,432	1,054
Hard coal retrofit 2 stops	16,200	16,280	1,004
CCGT 2 stops using shale gas	16,560	10,405	628
CCGT 2 stops using pipeline gas	16,560	7,007	423

Prognos (2017)

CCGT (16,560 MWh). Overall emissions compared to the non-retrofitted plant are higher (15.4 versus 16.2 kt), but emissions per kWh are lower due to reduced fuel use in the start-up procedure. However, overall emissions are lower than that of an inflexible coal power plant with a must-run operational mode.

Although the flexible operation of the coal power plant reduces its overall CO₂ emissions, the emissions produced by a CCGT plant operating under similar circumstances are always clearly lower. However, when the CCGT is fuelled with natural gas that has high lifecycle CO₂ emissions, the difference in overall emissions between the CCGT and hard coal power plants becomes smaller.

Considering the foregoing, some initial conclusions can be drawn:

- Power generation technologies have to be considered under similar dispatch conditions in order to compare cumulative CO₂ emissions.
- Lifecycle emissions depend on type of fuel and associated exploration and transportation technologies. Therefore, at the plant level, specific case-by-case evaluations have to be carried out.
- In general, coal fired power generation always leads to more CO₂ emissions compared to the use of natural gas, even when the use of shale gas is considered.
- Under must-run conditions, decreased minimum load levels lead to significantly lower CO₂ emissions for all types of fuels.
- Without must-run, the overall level of emissions can drop significantly, as the power plant stops generating during several hours. However, the specific emissions (g CO₂/kWh) of the power plant increase significantly, as start-up processes are CO₂-intensive.
- In specific cases, increasing the flexibility of a coal power plant may lead to higher overall emissions. This can happen if part load operation avoids to stop a plant during periods of non-profitable operation, without being compensated by avoiding the CO₂-intensive start-up processes. This underscores the need for effective CO₂ abatement policy that encourages plant operators to consider emissions when making operational decisions.
- In power systems dominated by coal generation, a significant share of coal power plants are needed to deliver system services and therefore operate under must-run conditions. In such a system, the flexible operation of coal power plants will have a significantly positive effect on the overall emissions of the power plant fleet.

While natural gas power plants generally cause lower CO₂ emissions than coal power plants, shifting from coal to natural gas in certain countries may not be a viable option, particularly if the country is highly dependent on coal. Indeed, when coal power dominates the market, established economic and political interests may prevent such a transition. Yet technical path dependencies are also an important hurdle, as tremendous investments in natural gas infrastructure may be needed to use natural gas as a bridge technology on the road to a fully decarbonised power system. By the same token, building new gas-based infrastructure as an interim solution could lead to new path dependencies, thus undermining the transition to a fully decarbonized system in the long-run. In such countries, increasing the share of renewables while simultaneously encouraging the flexible operation of existing coal plants is likely to be the most viable political and economic strategy.

5.3 Market design requirements to enhance the flexible operation of thermal power plants

The development of renewables has become one of the key driver for decarbonising energy systems. Enhancing the flexibility of power systems is therefore crucial for integrating higher shares of variable renewable energy in a cost efficient and reliable way. Against this backdrop, the power market needs to incentivise rather than hampers flexibility. Specifically, the power market must be designed to encourage the full exploitation of technical potentials for increasing flexibility.

Regulatory and market arrangements that provide clear price signals for the further development of renewables are increasingly important in countries seeking to incorporate larger RES shares. Extensive attention has been devoted to the interrelationships between market design and flexibility. The IEA has identified three market-design challenges for the remuneration of flexibility (cf. Figure 48). These challenges relate to (a) the capital intensive nature of renewables, (b) the limited predictability and variability of renewable output and (c) the fact that generation is decentralised.

The aim of this subsection is not to explore this discussion in detail, but rather to increase awareness for this topic by giving examples in which market design can incentivise flexibility.²⁷

In section 5.2, we discussed how renewables impact different aspects of the power system, placing new requirements on the operation of existing thermal power plants. The market segments impacted by RES are:

- Wholesale market: increasing RES shares transform the residual load curve, thus placing increased flexibility requirements on conventional power plants. Moreover, RES can decrease profitability due to the Merit-Order Effect.
- Balancing market: RES can increase balancing demand.
- Congestion management: RES can increase redispatch measures.

These market segments are strongly interdependent. Accordingly, inefficiency in one market segment can undermine efficiency in other segments, hampering overall flexibility, as the following example makes clear: A coal power plant in Germany with a net capacity of 500 MW, a minimal load of 40 percent (200 MW), generation costs of 15 EUR/MWh and hot start time of 150 minutes plans to provide 50 MW in the market for negative secondary balancing power. Negative balancing power is activated if real-time generation exceeds demand. Generation units typically provide negative balancing power by reducing their generation output. In the German balancing market, the regulations for secondary balancing power require balancing power to be fully activated within five minutes. Furthermore, the market design stipulates:

- the contracted capacity must be available for a period of seven days;
- seven days should typically pass between the end of an auction round – so-called “gate closure time” – and real time; and
- two products (with a 12h duration) can be chosen: peak and off-peak.

Thus, if a power plant wants to provide negative secondary balancing power, it has to provide the capacity for seven days. Moreover, since the start time (150 minutes) exceeds the required activation

²⁷ For further reading and a more detailed discussion, we recommend several studies recently published by Agora Energiewende: Power Market Operations and System Reliability (2014); The Power Market Pentagon (2016); Refining Short-Term Electricity Markets to Enhance Flexibility (2016); and The Integration Costs of Wind and Solar Power (2015).

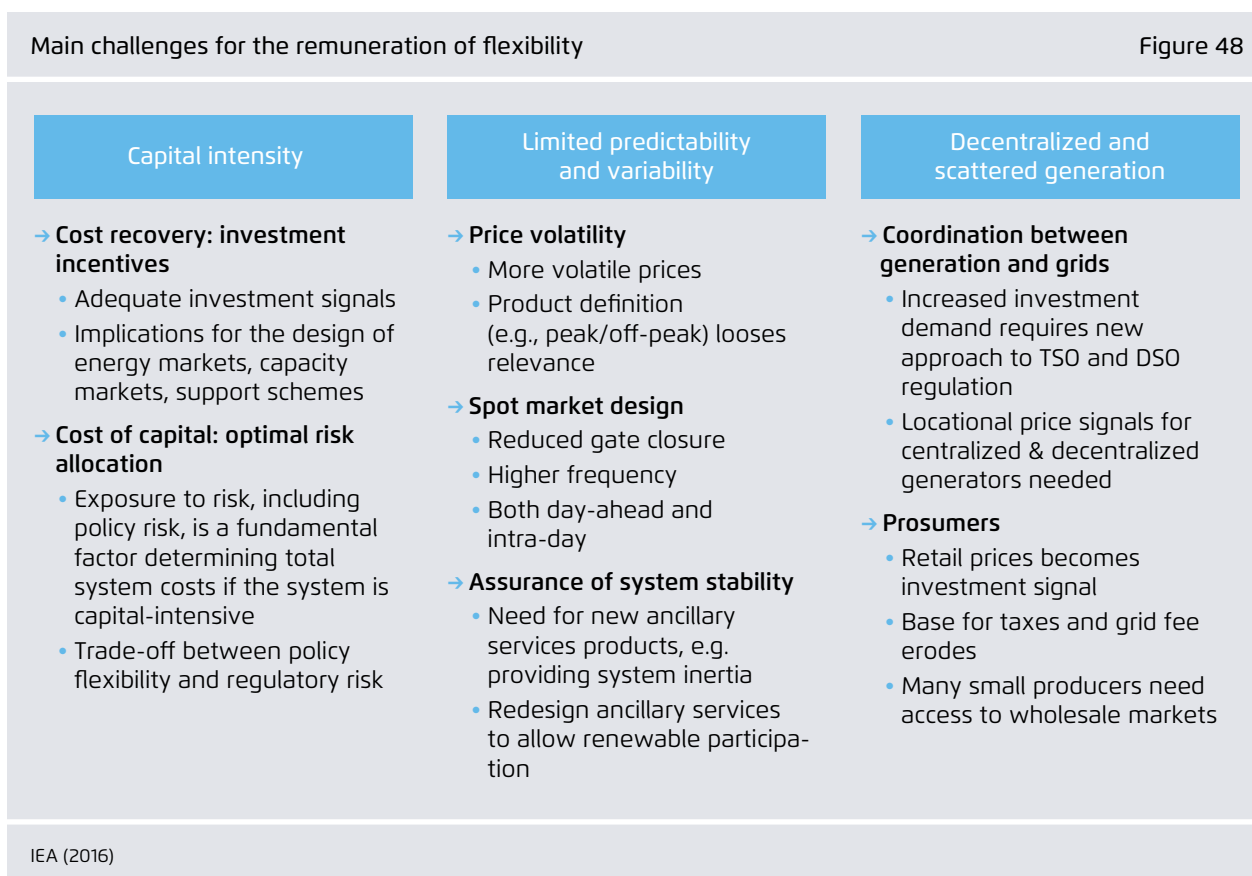

period for balancing capacity (5 minutes), the power plant must be active in the wholesale market (day-ahead market) in order to provide balancing power.

The market regulations mentioned above were established in a market environment with almost no renewable energy production. Within these boundaries, the system is reasonable and efficient: On the one hand, early gate closure (7 days before real time) and long contracting periods (7 days) offer higher planning security for grid operators. On the other hand, this regulatory arrangement incentivises baseload capacity to run 24/7. In our example, the coal power plant would be encouraged to run baseload in the day ahead market and reduce its capacity if negative balancing power is requested, due to its low marginal generation costs.

However, this market design becomes inefficient in a system with a high share of renewables, as it discourages flexibility. Over a longer period with low power demand and very high shares of RES, wholesale prices on the day-ahead market can easily fall below the actual generation costs of coal power (15 EUR/MWh). During such times, keeping a coal power plant running is not efficient. However, due to its balancing obligations, the power plant has to contribute 250 MW to the market (200 MW minimal load plus 50 MW negative balancing regulation). This can result in the curtailment of renewable generation. Moreover, this must-run capacity increases the flexibility demands placed on the remaining power system assets.

In this way, it can be more efficient to provide negative balancing power with other assets such as wind power. In order to do so, however, the market design

must be refined with shorter contracting periods, shorter product durations (e.g. 4 hours instead of 12 hours) and later gate closure (i.e. closer to real-time). Furthermore, freeing the coal power plant from its must-run balancing obligations would allow it to act more flexibly on the day-ahead market.

As described above, the design of the balancing market can have substantial impacts on day-ahead market dispatch and thus on the flexible operation of power plants. In addition to the day-ahead market, most countries have additionally introduced a second short-term wholesale market with later gate closure and shorter products. This so-called intraday market

enables buying and selling power up to 45 minutes before delivery. In contrast to the day-ahead market, power also can be traded in schedules of 15/30 minutes instead of hourly schedules. Here, again, liquid intraday markets have effects on balancing markets: On the one hand, late gate closure reduces forecasting errors for renewable energy and therefore decreases balancing requirements. On the other hand, 15-minute products reduce the balancing demand by diminishing the so-called schedule leaps. This interrelationship will be explained in the following sub-section.

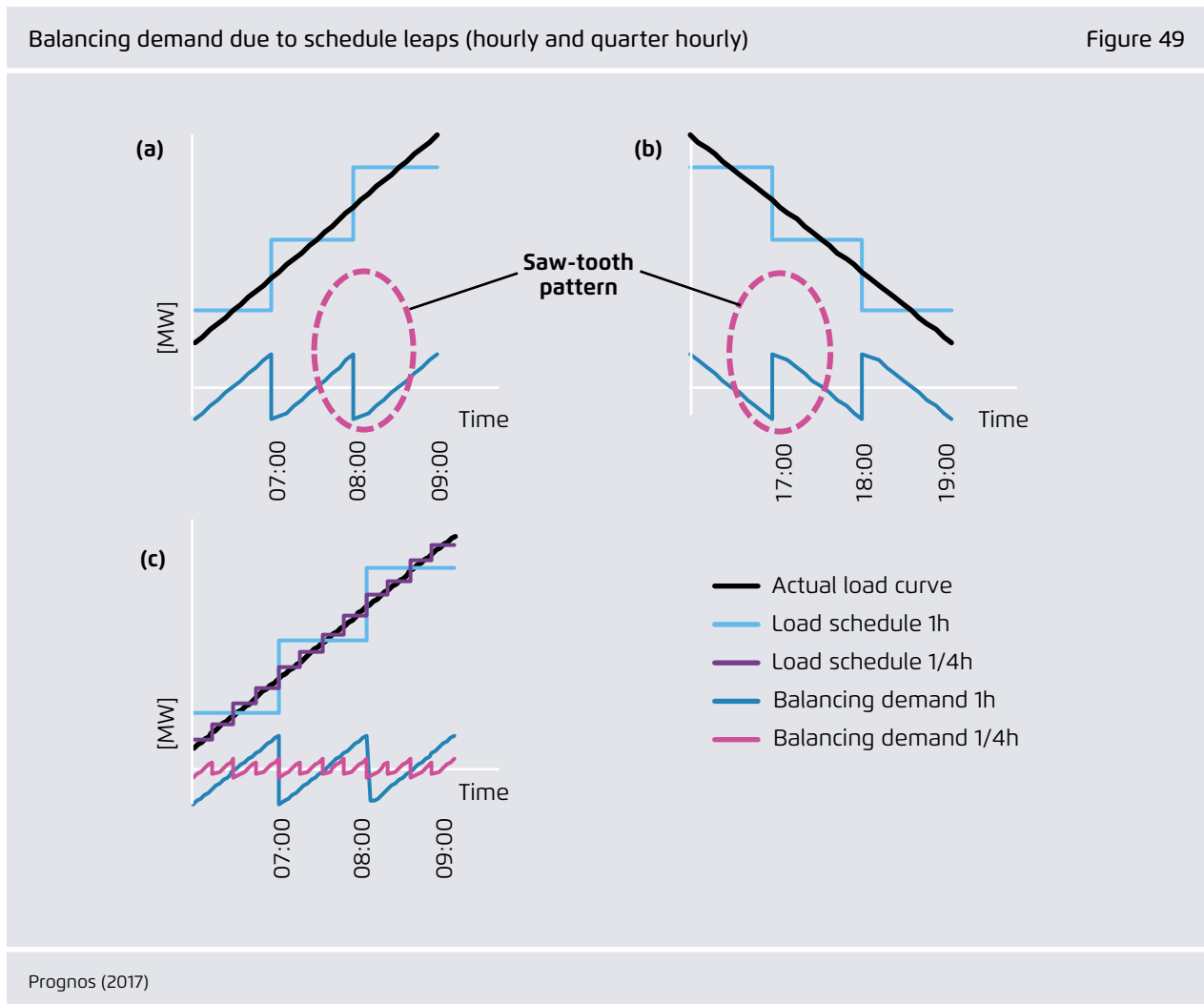

Schedule leaps

Power consumption and generation from wind and PV changes continuously, whereas trading (scheduled production) is done in discrete steps, e.g. 60-minute intervals. Balancing demand due to deviations between scheduling and actual loads or production are called schedule leaps or schedule jumps.

The figure demonstrates the phenomenon of schedule leaps by examining load procurement for a single power purchaser. To cover the load in its balancing group, the power purchaser procures the required power in hourly intervals on the wholesale market. On an hourly average, purchased energy equals demand. However, within each hour, the actual load deviates from the purchased (scheduled) load, thus causing balancing demand.

In the first 30 minutes of the morning hours (figure 49a), the scheduled load exceeds the actual load. Negative balancing power is required. In the second half of the hour, the situation reverses, and positive balancing power is required. In the evening hours (figure 49b) when the load gradient is negative, we see a mirror image of the same trend. This results in the typical saw-tooth pattern for balancing power demand – with right-tilted spikes in the morning hours and left-tilted spikes in the evening hours.

Figure 49c shows that the load procurement interval has a significant impact on the magnitude of balancing power demand. If the market design offers 15-minute products, electricity can be purchased and scheduled on a quarter-hour basis – which significantly lowers the demand for balancing power.

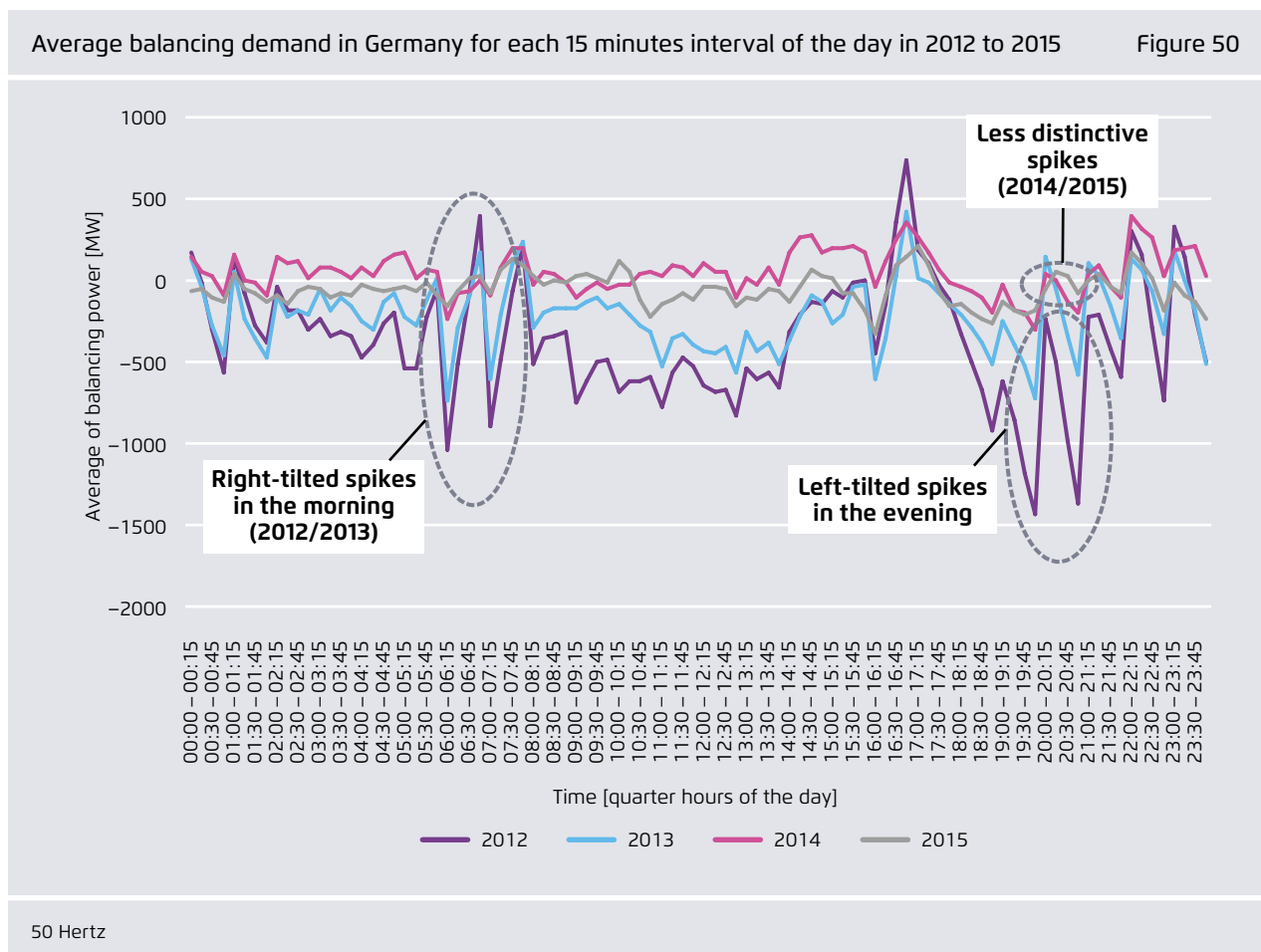

Figure 50 shows the average balancing demand for each quarter hour of the day in 2012 to 2015. The typical saw-tooth demand pattern caused by load schedule jumps can be clearly observed in empirical data on German balancing demand in 2012 and 2013: Balancing demand is characterised by right tilted spikes in the morning and left tilted spikes in the evening hours.

In 2014 and 2015 the pattern is less pronounced. This is attributable to the rise of the intraday market in German power trading, which significantly reduced the structural demand for balancing power associated with schedule leaps.

6. Profiles for Selected Countries: South Africa & Poland

In this section, questions concerning the flexibility of conventional power plants are discussed while spotlighting the market environment in South Africa and Poland, two countries with large coal power shares.

6.1 South Africa

Energy and climate policy

The primary vehicle for electricity policy in South Africa is the Integrated Resources Plan (IRP), which is part of the overall Integrated Energy Plan (IEP).

The main objective of the IRP is to provide sustainable long-term electricity planning while considering technical, economic and social constraints and externalities (DoE South Africa, 2016). The IRP is designed as a "living plan" that can be adapted to changing market conditions when necessary. The first IRP was designed for the period from 2010 to 2030 and remains the official government plan for new generation capacity. In November 2016, an update of the IRP 2010 was published as a draft for public consultation, which will take place in 2017. This update takes into consideration new economic and technical developments and enlarges the timeframe to 2050. The IRP is also considered to be the regulatory framework with the largest impact on South African climate policy.

The 2010 IRP sets forth a fixed target for new renewable capacity: namely, 17.8 GW by 2030, including 1 GW of solar CSP, 8.4 GW of solar PV and 8.4 GW of wind energy (DoE South Africa, 2013). The IRP also foresees new coal and nuclear power capacities. Specifically, 10 GW of new coal power plants should be built by 2020 (Eskom, the main power producer in South Africa, committed to constructing these plants before the IRP process). Some 9.6 GW of new nuclear power are planned, although nuclear capacity addi-

tions are not foreseen before 2022. Additional contributions are foreseen from natural gas CCGT (2.4 GW), natural-gas OCGT (3.8 GW), cogeneration and imports (mainly from hydro power plants in Mozambique and potentially also from Zambia, Zimbabwe and Zaire). By contrast, the draft version of the new IRP recommends the addition of 18 GW of PV, 37 GW of wind, 20 GW of nuclear, 34 GW of natural gas power plants, 2.5 GW of imported hydro and 15 GW of coal by 2050.

In the field of climate policy as a whole, some conditional commitments exist. South Africa has committed itself to achieving emissions reductions of 34 percent from business as usual by 2020 and reductions of 42 percent by 2025. Specific climate policies include a carbon tax (implementation is planned in 2017) and carbon budgets at the company level (planned for the period from 2016 to 2020). As part of the Paris Agreement, South Africa has published Intended Nationally Determined Contributions (INDC) and desired emission reductions. In this connection, it has communicated a peak, plateau and decline trajectory for its greenhouse gas emissions, with emissions slated to range between 398 and 614 Mt CO_{2,eq} in 2025–2030 and decline in the long term to 212 to 428 Mt CO_{2,eq} by 2050.

Power generation

South Africa has a long tradition of power generation from coal power plants, which cover about 90 percent of power needs. As the country has large hard coal resources, all coal power plants are fuelled with domestic hard coal. Major expansion of the coal fleet occurred in the 1960s and 70s due to economic growth and the substitution of oil with electricity after the oil crisis in the 1970s. This large-scale capacity expansion subsequently resulted in overcapacities in the late 1980s because electricity demand

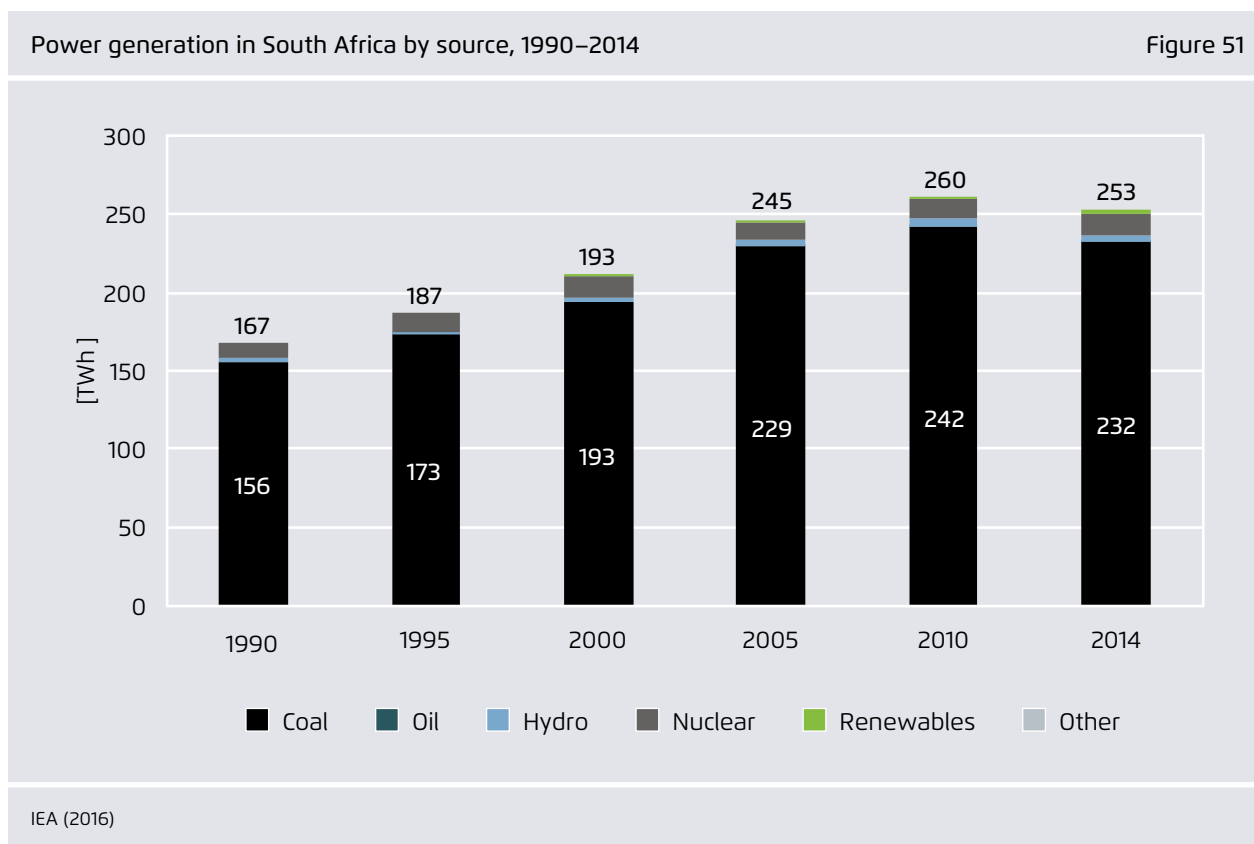

growth failed to meet forecasts. As a result, some overcapacities were temporarily shut down. However, in the late 1990s and early 2000s, a range of power plants were reactivated following forecasts of higher future demand.

South Africa's coal power plants are generally located near coal mines and remote from large cities. This is proving to be a liability due to the country's aging grid infrastructure, and security of supply is now a major concern.

Figure 51 shows the development of power generation in South Africa from 1990 to 2014. South African power generation was and remains dominated by coal power. Over the last 20 years, increasing demand for electricity has been mainly covered by new or recommissioned coal power plants.

Renewable capacities (including flexible hydro from pumped storage) have been introduced over the last 5–10 years, though their shares still remain quite low. Figure 52 shows statistics on power supply for 2014. More than 88 % (232 TWh) of South African power was generated by coal power plants, which were mainly operated in baseload mode. Nuclear power, which is the second largest individual source, accounted for just 5 % (15 TWh) of power generation. Meanwhile, renewables (including hydro) represented 2.4 % (over 6 TWh) of electricity generation in 2014.

Because of the dominance of coal power production, specific CO₂ emissions from power generation in South Africa are as high as 900 g CO₂/kWh. By contrast, specific CO₂ emissions in Germany amount to 500 g CO₂/kWh. CCS is often seen as an option for decarbonising electricity generation, but major challenges exist due to costs, uncertain geological conditions and the large distances between power

Power supply in South Africa
by source, 2014

Figure 52

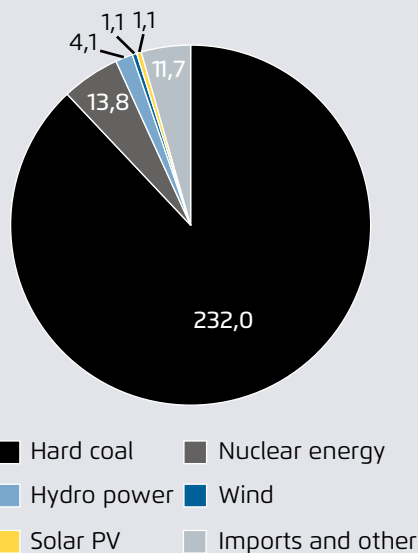

IEA (2016)

plants and possible storage facilities (which often exceed 600 km).

Beyond climate concerns, South Africa's growing power demand and ageing power plant fleet pose significant challenges, particularly with a view to security of supply. This is reflected by the narrowing margin between peak load and available capacity.

The country's coal power plants are old, poorly maintained and often pushed to their maximum capacity. The controlled load shedding that was implemented after the collapse of a coal silo at the Majuba Power Station in 2014 testifies to the poor state of South Africa's energy infrastructure. The early retirement of coal power stations is therefore constrained by security of supply problems. Moreover, grid infrastructure is weak and outdated.

Coal production

Coal production in South Africa is mainly based on hard coal and amounts annually to around 300 Mt. Bituminous coal accounts for 98.6% of coal production. South Africa does not produce lignite.

Proven coal reserves in South Africa are estimated at around 35 million tonnes, which comprise 3% of global reserves and 95% of African reserves. Sixty per cent of coal production is used for power generation, followed by synthetic fuels (20%) in industrial use. Besides domestic use, more than 20% of coal production is exported – mainly to the Pacific and Atlantic steam coal market.

The IRP forecasts increasing coal production (mainly for electricity generation), which raises a number of challenges. Some restrictions exist due to infrastructure problems, including in particular a lack of rail capacity. Furthermore, new coal mines will require extensive exploration and feasibility studies, because high-grade coal from the Central Basin will be depleted by 2040. Against the backdrop of South Africa's reliance on coal power and rising electricity demand, coal shortfalls are an increasing risk for energy security. The first coal supply shortages are expected to occur after 2018 if major investments are not realised (IEA CIAB, 2016).

Main characteristics of coal fired generation

South Africa's coal fired power stations are located in several multi-block sites, and are mainly found in one province, Mpumalanga. This province is also the epicentre of South African coal production. As most of the country's coal power plants are located a considerable distance from demand centres in the south-west and south-east, robust grid infrastructure is required to assure security of electricity supply in all regions.

Most of South Africa's power plants were constructed between the late 1970s and the early 1990s. With an average age of about 35 years, coal power plants in South Africa are relatively old compared to other

Age distribution of coal power plants in South Africa

Figure 53

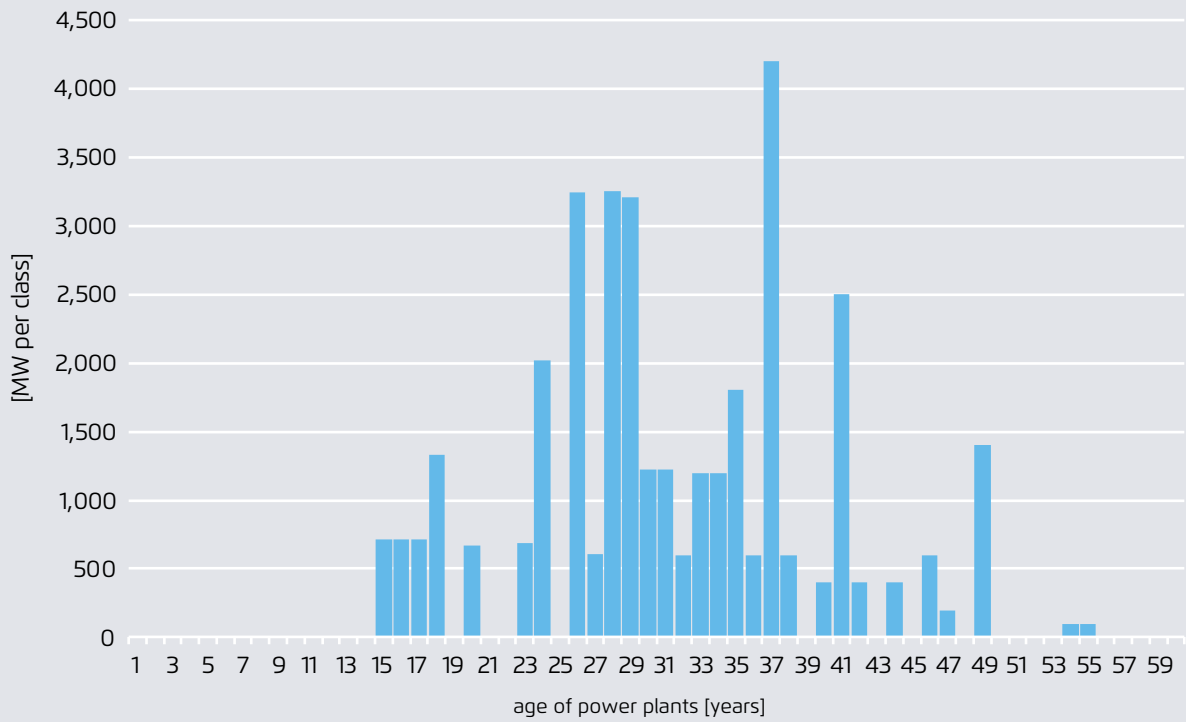

Eskom (2016)

Technical performance of coal power plants in South Africa

Figure 54

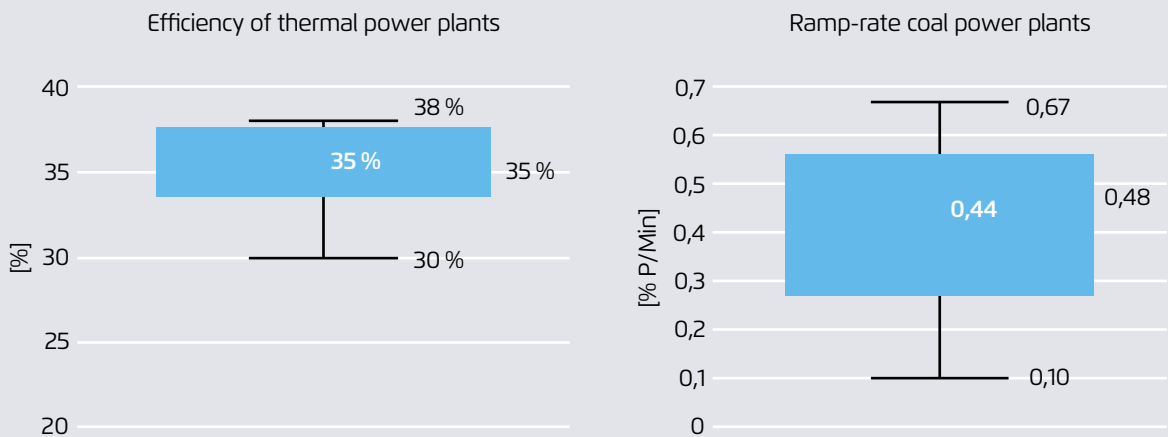

Eskom (2016)

countries (e.g. 20–25 years for coal power plants in Germany). Figure 53 shows the age structure of the South African power plant fleet.

Coal power plants in South Africa show an average plant efficiency of about 35 percent, which is well below the 40 percent average in most industrialised countries. Furthermore, the coal fleet is dominated by slag tap firing boilers, which generally reduces the flexibility of the existing coal fleet because of higher minimum load requirements.

South Africa's coal power plants thus display below-average minimum load levels as well as slow start-up times and ramp rates. The ramp rates of the country's coal power plants range between 0.1% and 0.7% of nominal capacity per minute. This is considerably lower than the standard for hard coal power plants (e.g. 1.5 to 4% per min as seen in chapter 3). Figure 53 compares ramp rate data. Specific figures on minimum loads are not publicly available.

With more than 50 GW of intermittent renewable generation planned by 2050 in the new IRP, flexibil-

ity requirements in South Africa are likely to increase in the future. As discussed above, more intermittent renewable generation significantly increases the flexibility requirements placed on power systems. Accordingly, the flexibility of conventional power plants (and electricity demand) is sure to become more important in South Africa in the coming years.

South Africa's coal power plants currently lag far behind the flexibility standards that are common for most commonly used hard coal plants elsewhere. As a result, there is a large potential for retrofitting measures to increase efficiency and flexibility, which would reduce coal consumption and CO₂ emissions. A range of options for increasing flexibility was described in section 4. Flexibility retrofitting in South Africa would require investment costs below 500 €/kW, as current examples in that section show.

Because South Africa's coal power plants mainly operate as baseload plants, flexibility retrofitting could also help to lower CO₂ emissions. Moreover, such retrofitting would help to reduce coal consumption, easing coal supply concerns.

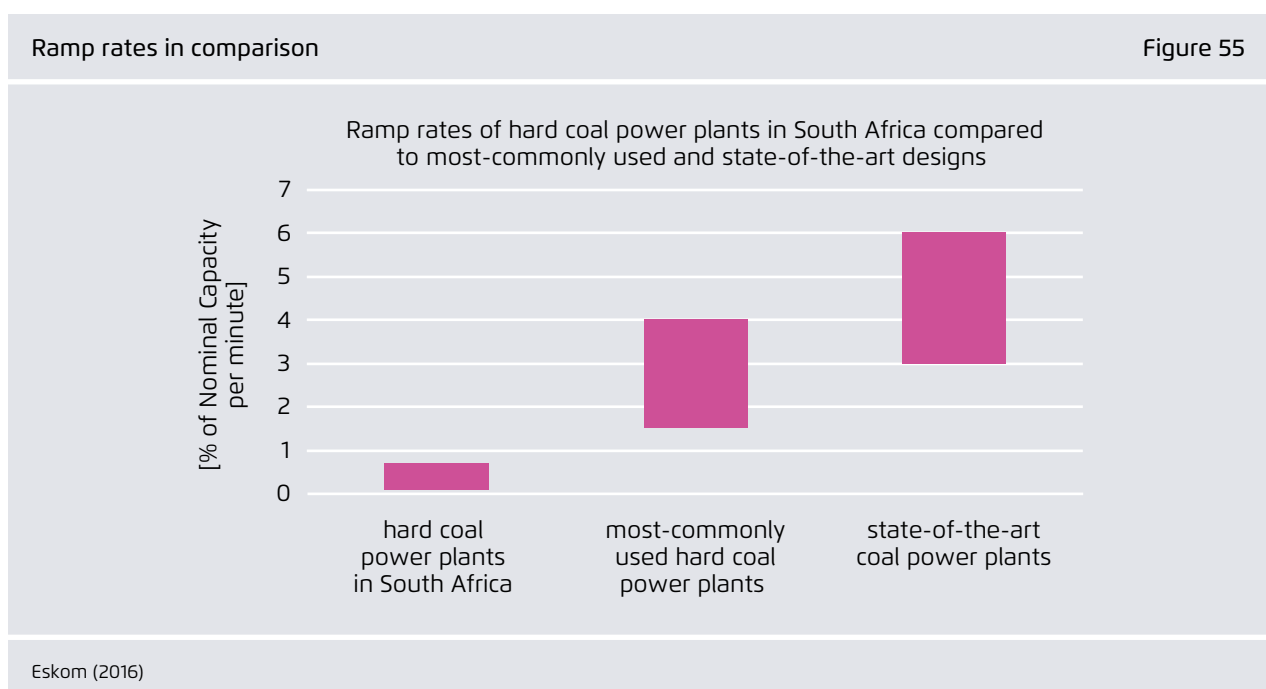

Alternative flexibility options

Beyond increasing the flexibility of coal power plants, a range of other flexibility options exist. The availability and viability of different flexibility options depend on the underlying conditions in each country and must be determined on a case-by-case basis.

Pumped storage and hydro storage power plants represent one flexibility option in South Africa. South Africa currently has total capacity of 3.5 GW in these technologies. Additional capacities in pumped storage are planned in the years up to 2025 (around 3 GW). Currently, planned pumped storage plants are expected to cost between 500 and 1,500 €/kW.

Another option is “demand side management” (DSM), which aims to increase the flexibility of electricity consumers. The South African utility Eskom is currently providing incentives for demand side management through its EEDSM (Energy Efficiency Demand Side Management) incentive program. An extremely wide range of DSM flexibility options are available. Furthermore, the costs associated with different options diverge considerably. Decentralised storage—for example, using PV systems in combination with batteries—is an additional solution that must be mentioned. Such technology could be an extremely viable option in the future, particularly if the costs of decentralised storage decrease further.

Gas power plants are another option for making conventional generation more flexible. The IRP is considering the addition of OCGT and CCGT plants in the future. However, the country’s lack of gas infrastructure limits the expansion of flexible gas power capacity. Furthermore, new gas power plants could lead to a potential lock-in situation and thus impede the transition to a fully decarbonised power system in the long-run.

In principal, the importation of electricity is an option for addressing regional imbalances in power supply and demand. However, South Africa’s grid infrastructure is weak, with limited connections to

neighbouring countries. Large additional investment would be needed to use power imports as a flexibility tool.

6.2 Poland

Energy and climate policy

Climate policy in Poland is principally determined by the climate policy of the EU. Poland has committed itself to limiting non-ETS GHG emissions to 14 percent (over 2005) and to increasing the share of renewables in gross final consumption by 15 percent by 2020.

In the field of energy policy, the National Renewable Energy Action Plan in Poland seeks to achieve renewable shares of 19 % in generation, 17 % in the heating/cooling sector and 10 % in the transportation sector by 2020. Reductions in CO₂ emissions in the ETS sector are to be realised primarily through the construction of efficient coal-fired power plants and by building new multi-fuel CHP plants.

The strategy paper “Energy Policy of Poland until 2030” (EPP) defines the current framework for Polish energy policy after 2020. Published in 2009, the EPP seeks to achieve the following:

- Improved energy efficiency
- Enhanced security of fuel and energy supplies
- Diversification of power generation with nuclear energy
- Increased use of renewable energy, including biofuels
- Establishment of competitive fuel and energy markets
- Reduction of environmental impact of the energy sector

The current government is expected to publish an updated version of the EPP in 2017. This revision should reflect the EU’s 2030 energy policy targets while forecasting developments in the Polish energy sector up to 2050 (IEA 2016).

Power generation

Figure 56 shows the development of power generation in Poland from 1990 to 2010. As can be seen from the data, power generation in Poland is dominated by coal power, which accounted for 85 % of power generation in 2014. Over the course of the last 20 years, growth in coal power generation has remained relatively flat. Additional power demand has been mainly covered by new natural-gas power plants and the expansion of renewables. In 2016, gross electricity production amounted to 166.6 TWh, including 22.8 TWh (13.7 percent) from renewables.

Figure 57 shows power generation by source in 2014. As can be seen from the data, coal generation is subdivided into hard coal (77.4 TWh) and lignite (54.2 TWh). Renewable generation mainly consists of wind power (8 TWh in 2014) and biomass (10 TWh in 2014). Because of Poland's dependency on coal generation and widespread use of lignite, specific CO₂ emissions amount to around 1000 g CO₂/kWh.

Power generation in Poland by source, 2014, in TWh

Figure 57

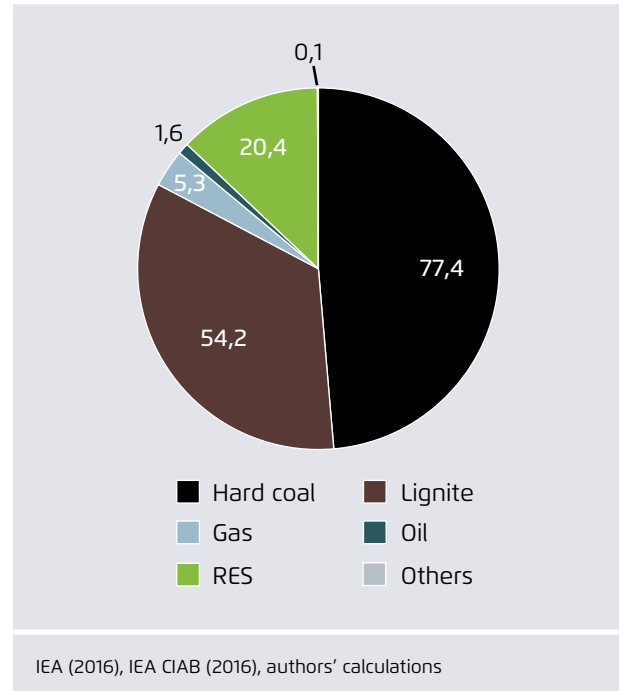

Power generation in Poland by source, 1990 to 2014

Figure 56

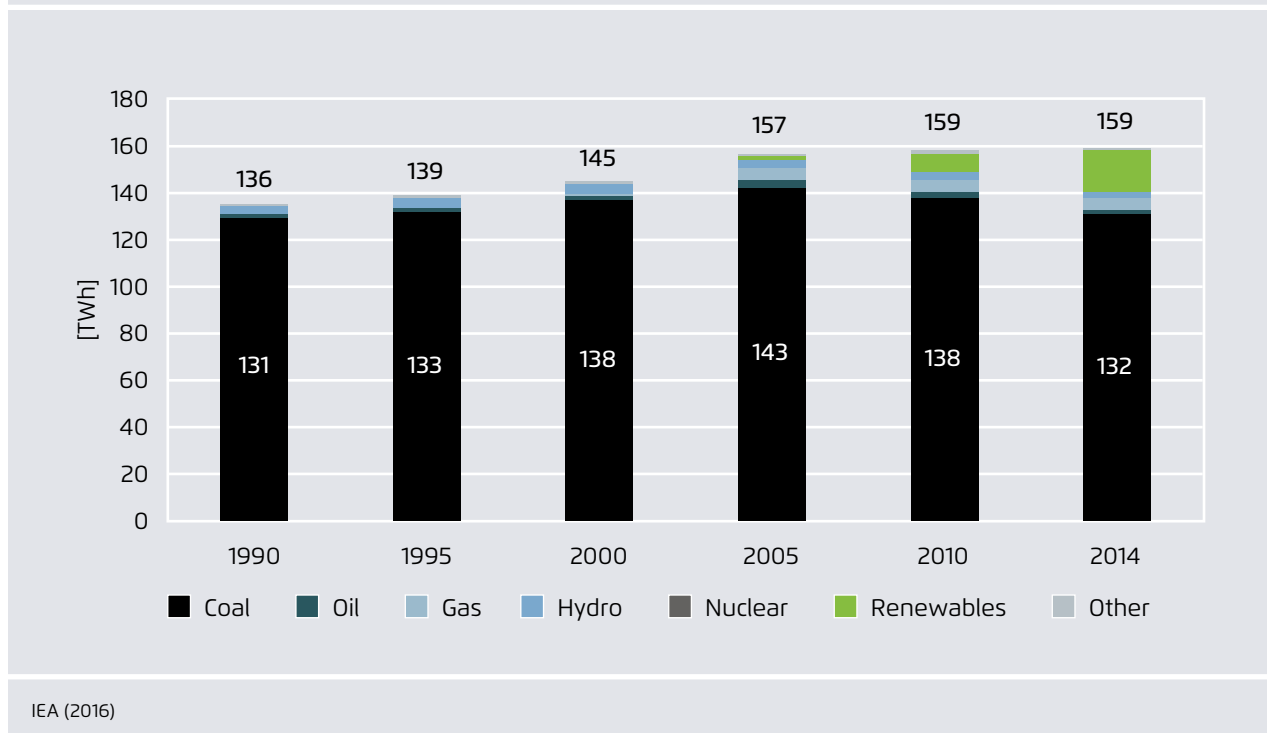

Some studies have forecasted that Poland will experience shortages at peak-load times in the near future. However, Poland's expansion planning up to 2020 should place security of supply levels well above that of other European countries. On the downside, this expansion will depend heavily on coal power, which could create technology lock-in problems, especially in the context of rising CO₂-prices lowering the profitability of coal power plants.

Poland is also planning to meet additional capacity requirements with two new nuclear power plants with a total capacity of 6 GW. In the Polish debate, nuclear power is considered a good option for avoid import dependency, because domestic coal production is restricted. However, the construction sites are not yet set and commercial operation is not expected before 2029.

Coal production

Coal production in Poland comprises around 140 Mt per year and is subdivided into lignite (64 Mt) and hard coal (73 Mt). Poland is the second largest producer of lignite in Europe after Germany but by far the largest producer of hard coal in Europe.

Hard coal production in Poland is currently down from considerably higher levels in the 20th century, when import quotas restricted coal imports. Poland has 60 billion tonnes of proven hard coal reserves. However, the country's industrial reserves are much lower, amounting to about 4 billion tonnes. Despite these considerable reserves, hard coal production in Poland is characterised by poor efficiency and competitive disadvantages to imports from Russia, Czech Republic and Ukraine.

Around 55% of primary energy consumption is based on coal and most of the coal production of Poland is used for domestic consumption.

Poland's coal and lignite industries will face major challenges in the coming decade. Indeed, Poland could face a coal and lignite production gap by 2030. The

closing down of unprofitable hard coal mines seems inevitable, and lignite mines are bound to be depleted before 2030.²⁸ Lignite production is expected to drop to roughly 10 Mt by 2033 if no new pits are opened.

If coal demand remains at current levels, Poland's domestic mining will have to be drastically restructured by 2030. Otherwise, Poland is likely to become a significant coal importer.

Main characteristics of coal fired generation

More than 80% of Poland's coal power plants were constructed between the late 1960s and 1990 (see Figure 58). Half of Poland's power plant fleet is more than 30 years old, and needs to be replaced or upgraded soon. Compared to other large coal fleets in countries like Germany, the fleet is 10 years older on average.

Given the average technical life time of coal and lignite stations is somewhere between 50 and 60 years, Poland will face a major challenge in modernising its power plant fleet within the next two decades. The strengthened EU air pollution standards for power plants that will be enforced by 2021 increase the pressure on the Polish power sector to take near-term action.

While few data on the technical aspects of the Polish fleet are publicly available, figures on Polish coal consumption indicate that the average efficiency of whole power plant fleet is well below 40%. Most boilers in operation were built by the Polish company Rafako and use the pulverised coal firing technology.

The Polish energy sector also faces similar challenges in the area of district heating due to the high share of CHP plants that are operated using hard coal and (and to a lesser extent) lignite (see Figure 59). Cogeneration

²⁸ Deloitte 2016, POLISH POWER SECTOR RIDING ON THE WAVE OF MEGATRENDS, https://www2.deloitte.com/content/dam/Deloitte/pl/Documents/Reports/pl_FAE_POLISH_POWER_SECTOR_RIDING_ON_THE_WAVE_OF_MEGATRENDS.pdf

Age distribution of coal and lignite fired power stations in Poland

Figure 58

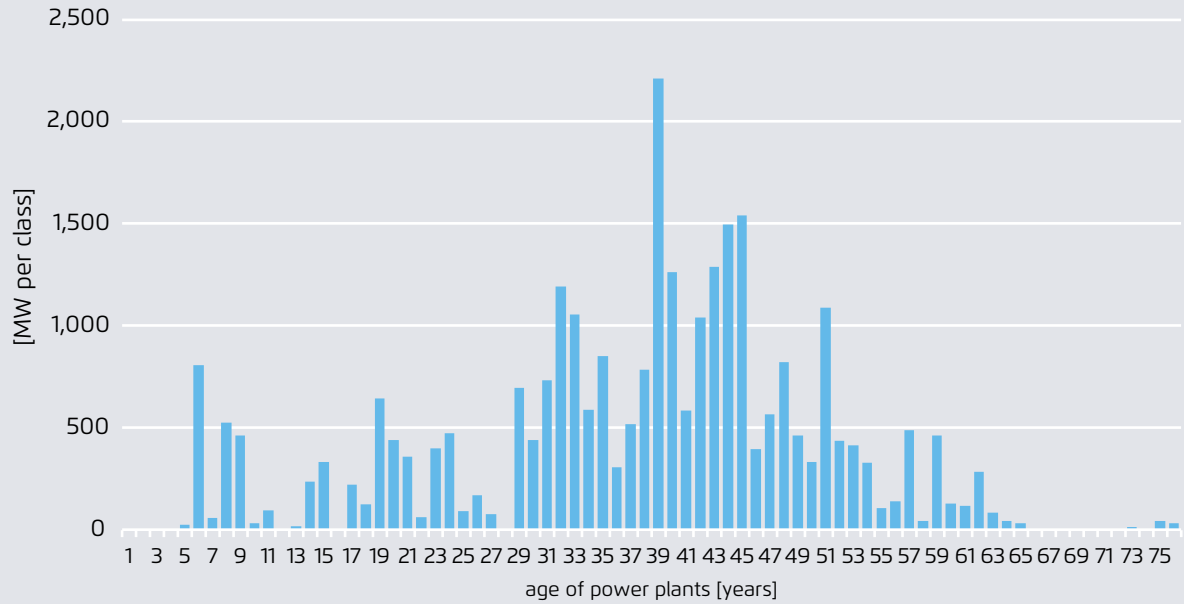

Authors' figure based on data from Platt

Unit size distribution for Polish coal and lignite fired power stations

Figure 59

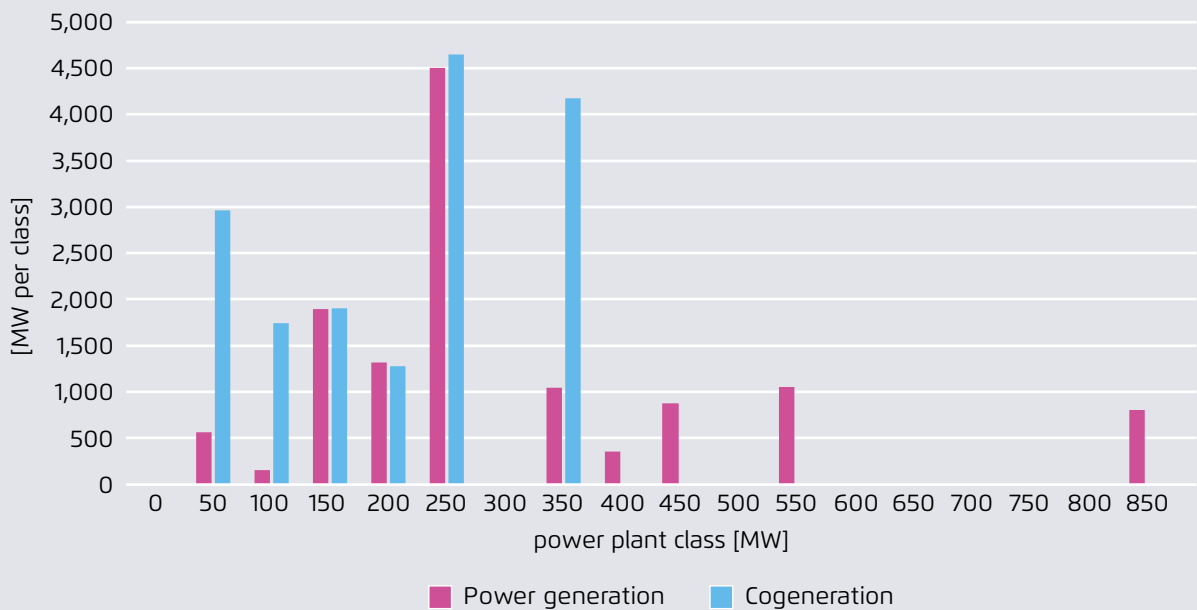

Prognos based on data from Platt

units usually have smaller average sizes than plants devoted solely to power generation.

The high share of CHP plants in Poland poses problems for the flexibility needs of the power system. During the heating period the need for heat supply puts CHP plants in must-run operation if heating needs cannot be covered by back-up boilers or different sources like industrial waste heat.

With an increasing share of renewables, new heat storage solutions can help to increase the flexibility of CHP plants. In Denmark and Germany numerous heat storage systems have been integrated into existing district heating systems to improve the operation of CHP plants. Energy production in the condensing mode provides another flexibility reserve in the CHP sector. This option is especially valuable during peak-load periods in the summer, and offers a flexibility potential of at least 1–2 GW.

Alternative flexibility options

Aside from measures to improve the flexible operation of coal power, Polish flexibility options are limited. As of today, gas and pumped storage hydro plants provide only a small potential, because their installed capacity is below 1 GW.

Grid connections to neighbouring electricity markets are also limited. During peak times, Poland only has about 2 GW of exchange capacity to its connected neighbours, including Germany, Sweden, the Czech Republic and Lithuania. The European Ten Year Network Development Plan (TYNPD) details projects for enhancing interconnector capacities to Germany, Sweden and Lithuania.

Another option for increasing flexibility is “demand side management” (DSM), which aims to increase the flexibility of electricity consumers. The utility company PGE is offering business clients services to manage their DSM potential. Various pilot projects also aim to implement DSM solutions in the household and commercial sectors. Despite the absence of good data on the country’s total DSM potential, one estimate places it at 1.2 GW (Forum Energii).

7. Conclusions

This paper provided a broad analysis on possible flexibility measures for thermal power generation, focusing on coal power plants. In doing so, we discussed technical and economic factors related to increasing the flexibility of those power plants, while also considering specific conditions in two countries (South Africa and Poland). Based on this discussion, some preliminary conclusions can be drawn:

Energy and climate policy

With the ratification of the Paris agreement, decarbonisation of the power sector has become a top priority for a range of countries. However, enhancing the flexibility of power systems is crucial if renewable generation is to be considerably expanded. A primary option in this regard is to operate power plants more flexibly. Existing coal power plants can contribute to this flexibility need through targeted retrofit measures. In addition to enabling higher renewable shares in the power system, coal power plant retrofitting can help to reduce CO₂ emission, in power systems characterized by very high shares of baseload or must-run coal power plants.

The structure of the existing power plant fleet

The advanced age and limited flexibility of existing coal power plants are the two main drivers of modernisation measures. Countries with old power plants that are designed for baseload operation can profit significantly from retrofitting measures to improve the efficiency and flexibility of their coal plants. While the costs of flexibility retrofitting have to be considered on a case-by-case basis, they can be roughly estimated at 100 to 500 €/kW (see section 4). Overnight construction costs for new coal fired power stations range from 1,200 €/kW to more than 3,000 €/kW if CCS technology is installed.

Market design and remuneration mechanisms for flexibility

The economics of retrofitting existing coal power plants are significantly influenced by the availability of remuneration options for flexibility. In the absence of such options, the market design will hamper investment in coal power flexibility and alternative flexibility tools. With rising renewable shares, markets should be tailored to promote the integration of actors that provide valuable flexibility options.

Alternative flexibility options

The specific benefits of coal power retrofitting are influenced by the availability of alternative flexibility options, including flexible generation from conventional power plants (e.g. gas, flexible hydro), demand-side flexibility and cross-border energy trading. The availability of these options varies considerable between countries due to structural, economic, and geographic factors.

Coal production

The threat of shortfalls in domestic coal production is constraining the development of coal power plants in a number of countries. However, concerns regarding the long term profitability of the coal industry and a lack of good sites have led to decreasing investment in the development of new coal mines. Coal plants in baseload operation consume tremendous amounts of highly specific types of coal and make tight coal supply situations foreseeable in the future if consumption remains high. If coal power plants can increase the flexibility of their operation while increasingly acting as a back-up for renewable generation, coal consumption can be reduced. This would extend the longevity of existing coal mines while reducing the need for new exploration. As decarbonisation progresses over the long run, coal power plants could be gradually phased-out or maintained as a strategic reserve, thus reducing coal consumption and emissions even further.

8. Bibliography

- ABB AG Power Systems Divison, 2013.** *Boiler Max – Optimize power plant start-up*. Mannheim: s.n.
- AG Energiebilanzen, 2016.** *Auswertungstabellen*. [Online] Available at: www.ag-energiebilanzen.de/10-0-Auswertungstabellen.html [Accessed 12 December 2016].
- Agora Energiewende (2015).** *The Integration Cost of Wind and Solar Power. An Overview of the Debate on the Effects of Adding Wind and Solar Photovoltaic into Power Systems*.
- Alstom, 2013.** *Ausbalanciertes Portfolio*, Kiel: 13. Technisches Presse Colloquiums.
- Alstom, n.d.** s.l.:s.n.
- Balling, L., 2010.** *Flexible future for combined cycle*. Modern Power Systems, December.
- Clerens, P. et al., 2015.** *Thermal power in 2030 – Added value for EU energy policy*, Brussels: European Power Plant Suppliers Association.
- Cziesla, F. et al., 2013.** *Fossil befeuerte Grosskraftwerke in Deutschland – Stand, Tendenzen, Schlussfolgerungen*, s.l.: VDI.
- Cziesla, F. et al., 2009.** *Advanced 800+ MW Steam Power Plants and Future CCS Options*, Katowice: s.n.
- FDBR, 2012.** *Anpassung thermischer Kraftwerke an künftige Herausforderungen im Strommarkt – Massnahmenkatalog*, Düsseldorf: Fachverband Anlagenbau Energie. Umwelt. Prozessindustrie.
- Fichtner, 2017.** Stuttgart: s.n.
- Franke, R. & Weidmann, B., 2008.** *Unter Dampf – Anfahr-optimierung von Dampfkesseln in E.ON-Kraftwerken*. s.l.:ABB Technik.
- Frohne, A., 2012.** *Kraftwerke im Umbruch – Antworten auf die Anforderungen der Energiewende*. Berlin: Dialogforum "Retrofit und Flexibilisierung konventioneller Kraftwerke".
- GE, n.d.** *Heat Recovery Steam Generators*. [Online] Available at: powergen.gepower.com/content/dam/powergen-pgdp/global/en_US/images/product/heat%20recovery%20steam%20generators/hrsg-approach.jpg [Accessed 18. November 2016].
- Gostling, J., 2002.** *Two Shifting of Power Plant: Damage to Power Plant Due to Cycling – A brief overview*, s.l.: s.n.
- Heinzel, T., Meiser, A., Stamatelopoulos, G.-N. & Buck, P., 2012.** *Einführung Eimühlenbetrieb in den Kraftwerken Bexbach und Heilbronn Block 7*. VGB PowerTech, November, pp. 79–84.
- INAS, 2014.** s.l.:s.n.
- Jeschke, R., Henning, B. & Schreier, W., 2012.** *Flexibility through highly-efficient technology*. VGB PowerTech, May, pp. 64–68.
- Klumpp, F., 2009.** *Energiewirtschaftliche Bewertung anfahrbedingter verursachter Instandhaltungskosten von Steinkohlekraftwerken*. Stuttgart: s.n.
- Kraft, A., 2015.** *Virtuelle Kraftwerke und Wärmespeicher*. s.l.:s.n.
- LEAG, n.d.** *Geschäftsfeld Kraftwerke*. [Online] Available at: kraftwerke.vattenfall.de/boxberg [Accessed 20. October 2016].

Michels, A., 2016. *Trockenbraunkohle erhöht die Flexibilität*, Bonn: BINE Informationsdienst – FIZ Karlsruhe.

Prognos, 2017. Berlin: s.n.

Quinkertz, R., Ulma, A., Gobrecht, E. & Wechsung, M., 2008. *USC Steam turbine technology for maximum efficiency and operational flexibility*, Kuala Lumpur: Siemens.

RWE Power AG, 2011. *Revision von Block E im Kraftwerk Neurath: Investitionen von 70 Millionen Euro steigern Effizienz und Flexibilität.* [Online] Available at: www.rwe.com/web/cms/de/2320/rwe-power-ag/presse-downloads/pressemitteilungen/pressemitteilungen/?pmid=4006805 [Accessed 13. October 2016].

RWE Power AG, 2011. *Revision von Block H im Kraftwerk Weisweiler: Investitionen von 65 Millionen Euro steigern Effizienz und Flexibilität.* [Online] Available at: www.rwe.com/web/cms/de/2320/rwe-power-ag/presse-downloads/pressemitteilungen/pressemitteilungen/?pmid=4006953 [Accessed 12. October 2016].

RWE Power AG, 2012. *Kraftwerk Weisweiler: Mit 60 Millionen Euro wird „Gustav“ fit gemacht für das Zusammenspiel mit Wind und Sonne.* [Online] Available at: www.rwe.com/web/cms/de/2320/rwe-power-ag/presse-downloads/pressemitteilungen/pressemitteilungen/?pmid=4008214 [Accessed 12. October 2016].

RWE Power AG, n.d. *Kraftwerk Weisweiler.* [Online] Available at: www.rwe.com/web/cms/de/60142/rwe-power-ag/energietraeger/braunkohle/standorte/kw-weisweiler/ [Accessed 13. October 2016].

RWE Power AG, n.d. *Kraftwerk Weisweiler.* [Online] Available at: [Kraftwerk Weisweiler](http://www.rwe.com/web/cms/de/60142/rwe-power-ag/energietraeger/braunkohle/standorte/kw-weisweiler/) [Accessed 19. October 2016].

Sarkar, D., 2015. *Thermal Power Plant – Design and Operation.* s.l.:Elsevier.

Scheffknecht, G., 2005. *Vorlesung Dampferzeugung.* Stuttgart: s.n.

Schmidt, G. & Schuele, V., 2013. *Anpassungen thermischer Kraftwerke an künftige Herausforderungen im Strommarkt.* Berlin: Alstom.

Schulze, U. & Hoffmann, H., 2013. *Vom Grundlastbetrieb zur flexiblen Leistungsbereitstellung.* s.l.:10. Jahrestagung Kraftwerke – Rückgrat der Energieversorgung.

SGS Industrial Services, 2011. *Case study.* s.l.:SGS SA.

Siemens, 2016. *Siemens Gas Turbines.* [Online] Available at: www.energy.siemens.com/co/pool/hq/power-generation/gas-turbines/downloads/gas-turbines-siemens.pdf [Accessed 18. November 2016].

STEAG GmbH, n.d. *Kraftwerk Duisburg-Walsum.* [Online] Available at: www.steag.com/s-kraftwerke-walsum.html [Accessed 20. October 2016].

Steck, M. & Mauch, W., 2008. *Technische Anforderungen an neue Kraftwerke im Umfeld dezentraler Stromerzeugung.* 10. Symposium Energieinnovation, 13.–15. February.

Strauss, K., 2016. *Kraftwerkstechnik zur Nutzung fossiler, nuklearer und regenerativer Energiequellen.* 7. Auflage ed. Dortmund: Springer Berlin Heidelberg .

Then, O., 2016. *What drives conventional power plants in Germany and Europe?.* Delhi: VGB PowerTech.

Trianel, n.d. *Daten und Fakten zum Kraftwerk*. [Online]
Available at: [www.trianel-luenen.de/kraftwerk/
daten-und-fakten/](http://www.trianel-luenen.de/kraftwerk/daten-und-fakten/)
[Accessed 19 October 2016].

VDE, 2012. *Erneuerbare Energie braucht flexible Kraftwerke – Szenarien bis 2020*, Frankfurt am Main: s.n.

Wietschel, M. et al., 2015. *Energietechnologien der Zukunft*. Wiesbaden: Springer Vieweg.

Ziems, C. et al., 2012. *Kraftwerksbetrieb bei Einspeisung von Windparks und Photovoltaikanlagen*, Rostock: VGB Powertech.

Publikationen von Agora Energiewende

IN ENGLISH

[The Cost of Renewable Energy](#)

A critical assessment of the Impact Assessments underlying the Clean Energy for All Europeans -Package

[Future Cost of Onshore Wind](#)

Recent auction results, long-term outlook and implications for upcoming German auctions

[The Energiewende in a nutshell](#)

10 Q & A on the German energy transition

[Energy Transition in the Power Sector in Europe: State of Affairs in 2016](#)

Review on the Developments in 2016 and Outlook on 2017

[Assessing the Winter Package in Light of the Energy Union Objectives](#)

[FAQ EEG – Energiewende: What do the new laws mean?](#)

Ten questions and answers about EEG 2017, the Electricity Market Act, and the Digitisation Act

[Reducing the cost of financing renewables in Europe](#)

A proposal for an EU Renewable Energy Cost Reduction Facility ("RES-CRF")

[Refining Short-Term Electricity Markets to Enhance Flexibility](#)

Stocktaking as well as Options for Reform in the Pentilateral Energy Forum Region

[Energy Transition in the Power Sector in Europe: State of Affairs in 2016](#)

Review on the Developments in 2016 and Outlook on 2017

[The Power Market Pentagon](#)

A Pragmatic Power Market Design for Europe's Energy Transition

[Energy Transition in the Power Sector in Europe: State of Affairs in 2015](#)

Review of the Developments and Outlook for 2016

[Projected EEG Costs up to 2035](#)

Impacts of Expanding Renewable Energy According to the Long-term Targets of the Energiewende

[Eleven Principles for a Consensus on Coal](#)

Concept for a stepwise decarbonisation of the German power sector (Short Version)

[The Integration Costs of Wind and Solar Power](#)

An Overview of the Debate of the Effects of Adding Wind and Solar Photovoltaics into Power Systems

[12 Insights on Germany's Energiewende](#)

A Discussion Paper Exploring Key Challenges for the Power Sector

Publikationen von Agora Energiewende

IN GERMANY

Die deutsche Braunkohlenwirtschaft

Historische Entwicklungen, Ressourcen, Technik, wirtschaftliche Strukturen und Umweltauswirkungen

Charta für eine Energiewende-Industriepolitik

Ein Diskussionsvorschlag von Agora Energiewende und Roland Berger

Neue Preismodelle für Energie

Grundlagen einer Reform der Entgelte, Steuern, Abgaben und Umlagen auf Strom und fossile Energieträger

Smart-Market-Design in deutschen Verteilnetzen

Entwicklung und Bewertung von Smart Markets und Ableitung einer Regulatory Roadmap

Energiewende und Dezentralität

Zu den Grundlagen einer politisierten Debatte

Wärmewende 2030

Schlüsseltechnologien zur Erreichung der mittel und langfristigen Klimaschutzziele im Gebäudesektor

All publications are available on our website: www.agora-energiewende.de

Agora Energiewende develops evidence-based and politically viable strategies for ensuring the success of the clean energy transition in Germany, Europe and the rest of the world. As a think tank and policy laboratory we aim to share knowledge with stakeholders in the worlds of politics, business and academia while enabling a productive exchange of ideas. Our scientifically rigorous research highlights practical policy solutions while eschewing an ideological agenda. As a non-profit foundation primarily financed through philanthropic donations, we are not beholden to narrow corporate or political interests, but rather to our commitment to confronting climate change.



Agora Energiewende

Anna-Louisa-Karsch-Straße 2 | 10178 Berlin

P +49 (0)30 700 14 35-000

F +49 (0)30 700 14 35-129

www.agora-energiewende.de

info@agora-energiewende.de

